

# Soft Starter VEDA-IN SFT50



## Contents

<b>INTRODUCTION</b> .....	<b>5</b>
<b>Chapter 1 Safety Instructions</b> .....	<b>6</b>
1.1 Precautions.....	6
1.2 Soft Starter.....	7
<b>Chapter 2 Product Specifications and Arrival Inspection</b> .....	<b>8</b>
2.1 Product Specifications .....	8
2.2 Product Series Introduction.....	9
2.2.1. Arrival Inspection .....	9
2.2.2. Model Type Code .....	9
2.2.3. Selection of Specifications and Accessories .....	10
<b>Chapter 3 Installation and Wiring</b> .....	<b>11</b>
3.1 Mechanical Installation of Soft Starter.....	11
3.2 Electrical Installation of Soft Starter.....	13
3.2.1. Overview.....	13
3.2.2. I/O Power Circuit and Control Terminals.....	14
3.2.3. Control Circuit Configuration and Wiring .....	16
3.2.4. Field Wiring and Grounding Requirements.....	16
3.2.5. Safety Precautions .....	18
<b>Chapter 4 Soft Starter Operation Instructions</b> .....	<b>18</b>
4.1 Terminology .....	18
4.2 LCD Keypad Display Unit Description .....	18
4.2.1. Keypad Function Description.....	19
4.2.2. Indicator Description.....	19
4.2.3. Information Screen Introduction and Operation.....	20
4.2.4. Soft Starter Parameterization Process.....	21
<b>Chapter 5 Detail Function Description and Settings</b> .....	<b>23</b>
5.0 Start Mode (F-00).....	24
5.1 Soft Start Time (F-01).....	25
5.2 Soft Stop Time (F-02).....	25
5.3 Stop and Start Voltage (F-03).....	25
5.4 Current Limit Amplitude (F-04) .....	26
5.5 Forced Start Voltage (F-07) .....	26
5.6 Run Overcurrent (F-11).....	27
5.7 Overload Protection (F-12) .....	27
5.8 Overvoltage Protection (F-16).....	28
5.9 Undervoltage Protection (F-17).....	28

5.10	Output Phase Loss (F-18)	28
5.11	Module Overtemperature (F-19)	29
5.12	Timeout Protection (F-20)	29
5.13	Imbalance (F-21)	29
5.14	Communication (F-23–F-29)	29
5.15	Analog Output (F-30)	30
5.16	Initialization (F-32)	30
5.17	Language Selection (F-33)	30
5.18	Motor Current (F-34)	30
5.19	Factory Password (F-35)	30
<b>Chapter 6 Troubleshooting</b>		<b>30</b>
<b>Chapter 7 Maintenance and Repair</b>		<b>32</b>
7.1	Product Servicing and Inspection	33
7.2	Regular Maintenance	33
7.3	Soft Starter Storage	34
7.4	Product Warranty	34
<b>Appendix 1: Application Example Diagram</b>		<b>36</b>
<b>Appendix 2: Dimensional Drawing</b>		<b>37</b>

VEDA-IN DRIVES provides customers with a full range of technical support, users can contact the nearest office, agents or Technical Support Center, or directly contact the company headquarters.

The information in this manual is subject to change without notice.

The agent or distributor shall not be responsible for any errors or omissions in this manual or for any inevitable damage that may be caused by the execution or use of this manual.

The information in this user manual is protected by the copyright law. Without the written authorization of the copyright owner, all or part of the contents in this manual may not be photocopied or copied in any form, and the copy shall be investigated.

Copyright@2021 All rights reserved

## INTRODUCTION

Thank you for purchasing SFT50 soft starter. Thank you for your support of VEDA-IN DRIVES.

We will repay your loyalty with excellent product quality!

SFT50 soft starter contains components and materials of a state-of-the-art microprocessor control system. This product is a high-quality device that integrates motor soft start, soft stop, energy saving and multiple protection functions for use as a constant speed AC motor drive. Compared to conventional starting methods, the use of SFT50 soft starter allows a smooth variation of voltage, torque and current to be implemented on the motor and, as a result, the mechanical loads are significantly optimized; extensive motor protection functions have played a very important role in extending the life of the motor; at the same time, Modbus RTU communication function has been implemented.

In order to facilitate your use, this manual will provide you with relevant instructions such as installation, wiring, parameter setting, troubleshooting and daily maintenance. In order to ensure that you can correctly install and use SFT50 soft starter and give full play to its superior performance, please read this user manual carefully before installation and keep it properly.

As a power electronic device, during the operation and use of the soft starter, for the safety of you and the equipment, be sure to leave it to professional engineers to install and debug and set the parameters. Thank you!

Reader object

This manual is suitable for reading by the following persons:

Equipment installation personnel, maintenance, care personnel, designers

## Chapter 1 Safety Instructions

### 1.1 Precautions



#### ATTENTION!

- Before operating this equipment, please read the user manual carefully and strictly follow the operation instructions of the manual.
- During installation and maintenance strictly follow the relevant national standards and industry practices of the manual.
- The manufacturer is not responsible for any adverse consequences caused by not following the corresponding guidelines and specifications.
- Make sure that the soft starter wiring is correct and the safety measures are adequately taken before closing.
- Before maintaining the soft starter or motor, all power inputs must be disconnected.
- Do not place flammable materials near the soft starter, otherwise there is a danger of fire.
- It is strictly prohibited to install the soft starter in an environment containing explosive gas, otherwise there is a danger of explosion.
- Wiring must be performed by qualified personnel otherwise there is a danger of electric shock.
- When optional accessories are required, it is recommended to use special accessories for soft starters from VEDA-IN DRIVES to avoid potential safety hazards.
- The power circuit terminal and the wire nose must be firmly connected, and the exposed part of the cable nose for power circuit wiring must be wrapped with insulating tape to avoid potential safety hazards.



#### Warnings

- After the product is connected to the power supply, the voltage inside the device in separate locations on the PCB is equal to the main voltage. If it is touched in violation of the regulations, it will be very dangerous and may cause electric shock injury or death.
- Once the product is connected to the mains, even after the control voltage is removed or the soft starter is stopped, there will be voltage at the output of the soft starter.
- Pay attention to the danger of electric shock. Do not touch the soft starter with wet hands.
- In order to ensure your safe use and prevent accidental electric shock, ensure that the product is well grounded.
- It is strictly forbidden to connect the power factor compensation capacitor to the output of the soft starter.



Implementation Standards

- This product is designed to meet the requirements of IEC60947-4-2.



Warnings

- During transportation, do not pull the soft starter by the display unit and cover to avoid personal injury or damage to objects.
- Do not drop foreign objects such as screws, gaskets, and metal rods into/onto the soft starter, otherwise there is a danger of fire and damage to the device.
- Do not install in places where water droplets may splash, such as water pipes.
- If the soft starter is damaged or the parts are incomplete, do not install or run it, otherwise there is a danger of fire and personal injury
- Do not install in direct sunlight.

### 1.2 Soft Starter

Capacitors to improve power factor or lightning protection devices can cause soft starter false trips or damage to the components. Be sure to remove them. As shown in Figure 1-1:

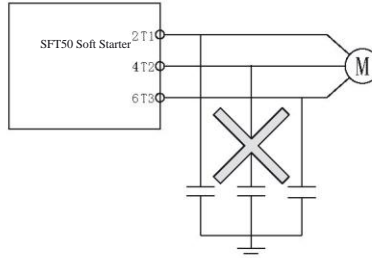

Figure 1-1 The use of capacitors at the output of the soft starter is prohibited

#### Switching Devices such as Contactors at the Output

If you need to install a switching device such as a contactor between the output of the soft starter and the motor, make sure that it switches when the soft starter is off, otherwise the soft starter may be damaged.

#### Input Overvoltage

Input voltage should be in the range of soft starter's rated voltage.

#### Lightning Protection

The soft starter is equipped with a lightning overcurrent protection device, which has a certain self-protection ability for induction discharges.

#### Altitude and Derating Use

In areas with an altitude of more than 1000 meters, the heat dissipation effect of the soft starter becomes poor due to the thin air, so it must be derated. Figure 1-2 shows the relationship between the rated current of the soft starter and the altitude.

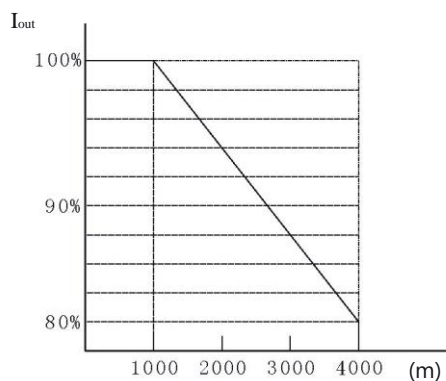

Figure 1-2 Relationship between rated output current of soft starter and altitude

## Chapter 2 Product Specifications and Arrival Inspection

### 2.1 Product Specifications

Table 2-1 Product specifications

Specification	Value	
Applicable standards	GB14048.6-2016 (IEC60947-4-2)	
Adapted motor type	Three-phase asynchronous motor	
Motor current	11 A - 1260 A(5.5~630 kW)	
Input	Control source voltage	220 VAC $\pm$ 15%; 50/60 Hz
	Rated main voltage	380 VAC $\pm$ 15%; 50/60 Hz; 690 VAC $\pm$ 15% (specify when ordering)
Adjustable starting time	1~120 s adjustable	
Adjustable stop time	0~120 s adjustable	
Control mode	1. Linearly variable voltage 2. Linearly variable current 3. Current limit mode	
I/O	Digital input	3 channels (X1- X3)
	Analog output	1 channel 4~20 mA/0-10 V
	Relay output	2 relay outputs
	Run command input	Keyboard display unit setting, control terminal setting RS485 communication is given
Communication protocol		Standard Modbus protocol, 1 channel
Display unit	LED/LCD display	Can display current, voltage, alarm and other motor parameters
Protection and monitoring	Short circuit overvoltage, undervoltage, phase loss, overcurrent, temperature protection	



Specification	Value	
Environment	Installation	Indoor, free from direct sunlight, dust, corrosive and flammable gases, oil mist, water vapor, dripping water or salt, etc.
	Altitude	If the altitude exceeds 1000 m, the capacity should be reduced accordingly. For every 100 m increase, the current decreases by 0.5%
	Ambient temperature	10 °C ~ +40 °C the change of air temperature is less than 0.5 °C / MIN; For temperatures above 40 °C, reduction factors must be used and the output current will be reduced by 2% for every 1 °C exceeded, maximum temperature is 50 °C
	Humidity	Less than 95% RH, no condensation
	Vibration	Less than 5.9 m/s <sup>2</sup> (0.6 g)
	Storage temperature	-40 °C ~ 70 °C
Design	IP rating	IP20
	Cooling method	Radiator, natural cooling
Installation method	Vertical installation inside the cabinet	

## 2.2 Product Series Introduction

### 2.2.1. Arrival Inspection

Before leaving the factory, this product has undergone strict quality inspection and is packed with anti-collision and anti-shock packaging. However, accidents may occur during transportation and handling. Therefore, after you receive the product, please immediately check the arrival of the product.

- ① Check whether the soft starter was damaged during transportation.
- ② Check the nameplate of the motor soft starter to ensure that the product you receive is the product you ordered.
- ③ The box contains SFT50 soft starter and the user manual. If any of the above listed items is missing or damaged, please contact your local agent, dealer or our technical service center directly.

### 2.2.2. Model Type Code

Table 2.2-2. Type code structure of SFT50 soft starter

VM-50-PXXX-XXXX-TX-CV2		
VM-50	SFT50 product series	
TX	Voltage class (T=3 phases)	
	T4	3 × 380 V
	T6	3 × 690 V
XXXX	Rated current, A	
220V	Control voltage 220V	

### 2.2.3. Selection of Specifications and Accessories

The body type and matching power of SFT50 soft starter are shown in the table:

Table 2.2.–3.1 Size number and matching power of SFT50-380V are shown below

Model	Motor power (kW)	Rated current (A) 380 V	Body	Recommended cross-section	Control power supply minimum capacity, VA
11A00MAE001	7.5	22	F1	6 mm <sup>2</sup>	195
11A00MAE002	11	27	F1	10 mm <sup>2</sup>	195
11A00MAE003	15	30	F1	10 mm <sup>2</sup>	195
11A00MAE004	18,5	34	F1	16 mm <sup>2</sup>	195
11A00MAE005	22	38	F1	16 mm <sup>2</sup>	195
11A00MAE006	30	65	F2	25 mm <sup>2</sup>	300
11A00MAE007	37	70	F2	25 mm <sup>2</sup>	300
11A00MAE008	45	88	F2	35 mm <sup>2</sup>	300
11A00MAE009	55	110	F3	50 mm <sup>2</sup>	400
11A00MAE010	75	140	F3	70 mm <sup>2</sup>	400
11A00MAE011	90	172	F4	25*3 copper wires	905
11A00MAE012	110	200	F4	25*3 copper wires	905
11A00MAE013	132	280	F5	40*3 copper wires	1600
11A00MAE014	160	320	F5	40*3 copper wires	1600
11A00MAE015	185	355	F5	40*5 copper wires	1600
11A00MAE016	200	380	F5	40*5 copper wires	1600
11A00MAE017	220	440	F5	40*5 copper wires	1600
11A00MAE018	250	480	F5	40*5 copper wires	1600
11A00MAE019	280	560	F6	50*5 copper wires	3678
11A00MAE020	315	600	F6	50*6 copper wires	3678
11A00MAE021	355	700	F6	50*6 copper wires	3678
11A00MAE022	400	780	F6	50*8 copper wires	3678
11A00MAE023	450	820	F6	50*8 copper wires	3678

 Note:

1. When ordering, please inform the supplier of the product model, specifications load and use conditions in order to correctly select the product.
2. The standard soft starter configuration of this model includes the bypass contactor and the current detectors.

The accessories in the above table are for reference only.

The body type and matching power of SFT50 soft starter are shown in the table:

Table 2.2.–3.2 Size number and matching power of SFT50-690V are shown below

Model	Motor power (kW)	Rated current (A) 690 V	Body	Control power supply minimum capacity, VA
11A00MAE027	30	31	F2	300
11A00MAE028	37	38	F2	300
11A00MAE029	45	46	F2	300
11A00MAE030	55	57	F2	300
11A00MAE031	75	77	F2	300
11A00MAE032	90	93	F3	400
11A00MAE033	110	114	F3	400
11A00MAE034	132	136	F4	905
11A00MAE035	160	165	F4	905
11A00MAE036	185	191	F4	905
11A00MAE037	200	207	F5	1600
11A00MAE038	220	227	F5	1600
11A00MAE039	250	258	F5	1600
11A00MAE040	280	289	F5	1600
11A00MAE041	315	325	F5	1600
11A00MAE042	355	367	F5	1600
11A00MAE043	400	413	F5	1600
11A00MAE044	450	465	F5	1600

 Note:

1. When ordering, please inform the supplier of the product model, specifications load and use conditions in order to correctly select the product.
2. The standard soft starter configuration of this model includes the bypass contactor and the current detectors.

The accessories in the above table are for reference only.

## Chapter 3 Installation and Wiring

### 3.1 Mechanical Installation of Soft Starter

The soft starter should be installed indoors and in a well ventilated place; vertical installation, do not install it upside down, obliquely or horizontally; the base should be firm and flat. Leave enough space around.

When choosing an installation environment, you should pay attention to the following:

- 1) The ambient temperature should be in the range from -10 °C to +40 °C. If the temperature exceeds 40 °C, heat dissipation measures or derating should be adopted;
- 2) The humidity requirement is lower than 95%, and no water condensation occurs;
- 3) Install in a place where the vibration is less than 5.9 m / s<sup>2</sup> (0.6 g);
- 4) Avoid installing in direct sunlight;
- 5) Avoid installing in dusty and metal powder places;

6) It is strictly forbidden to install in places with corrosive or explosive gas;

 Note:

If there are special installation requirements, please consult and confirm in advance.

Installation interval and distance requirements, as shown in Figure 3-1a:

When multiple soft starters are installed, as shown in Figure 3-1b, when the two soft starters are installed up and down, a deflector should be added in the middle as shown in Figure 3-1c.

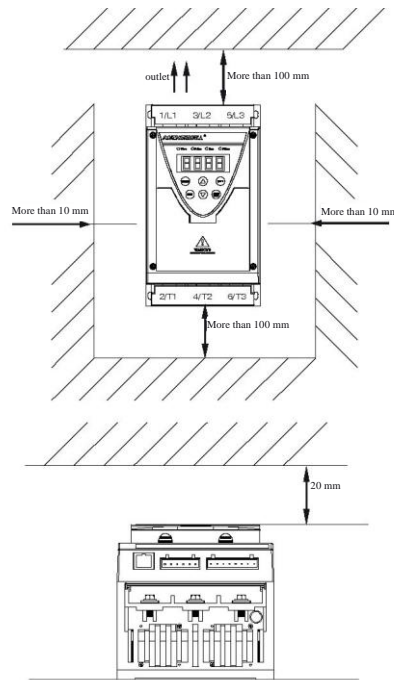

Figure 3-1a Installation space distance (mm)

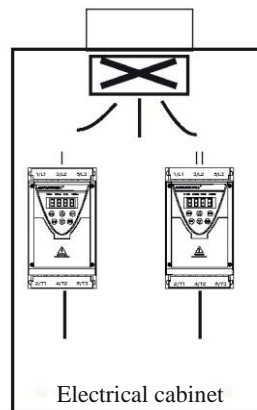
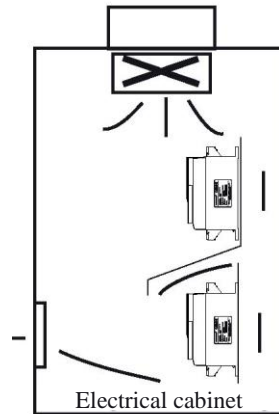

Figure 3-1b Multiple installation



The ventilation direction is shown in Figure 3-1d:

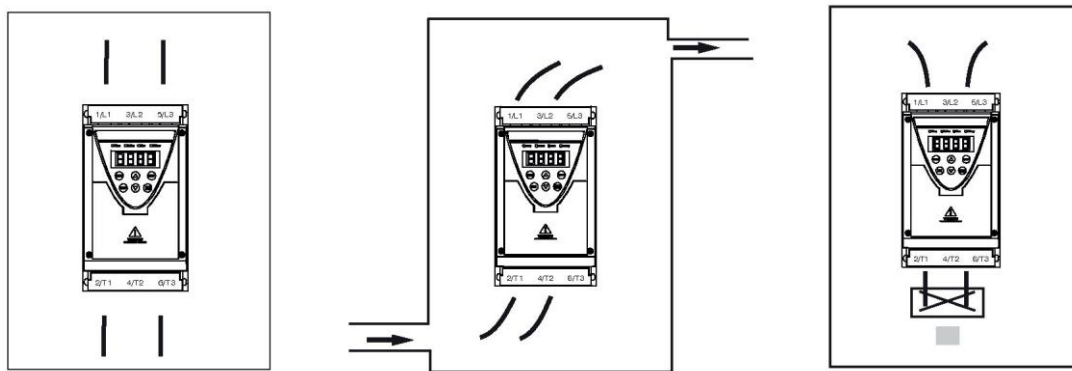

Figure 3-1d Ventilation direction

Please install according to the above installation space to ensure that this product can work normally in a good environment.

For special installation requirements, please contact the manufacturer in advance.

### 3.2 Electrical Installation of Soft Starter



#### Warnings

- Only after confirming that the power supply of the soft starter is reliably cut off and the supply indicator of the display panel goes out, wait 3 minutes before opening the panel.
- Only after confirming that the power of the main circuit of the soft starter has been reliably disconnected, the wiring of the main circuit and the control circuit can be performed.
- Please carefully check the voltage level of the soft starter before power on, otherwise equipment damage and personal injury may be caused.

#### 3.2.1. Overview

SFT50 series wiring part is divided into main circuit and control circuit. Users can choose different connections according to different needs.

The main circuit consists of three-phase input power cables and motor power cables, as shown in Figure 3-2b

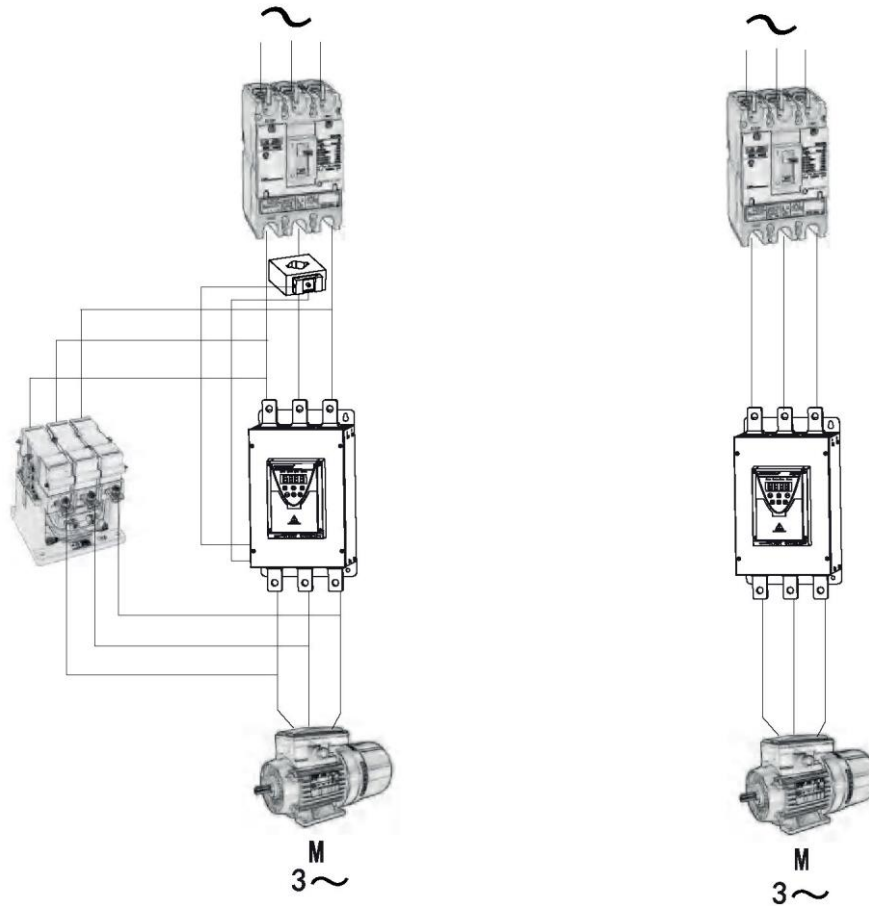

Figure 3-2a Wiring diagram for the power circuit of the soft starter without bypass contactor. Figure 3-2b Wiring diagram for the power circuit of SFT50 soft starter

### 3.2.2. I/O Power Circuit and Control Terminals

The sequence of the input and output terminals of the power circuit is shown in Figure 3-3:

The power circuit input and output terminal functions are shown in Table 3-1

Table 3-1 Main circuit input and output terminal function table

Terminal symbol	Description
1/L1 3/L2 5/L3	3phase AC power input
2/T1 4/T2 6/T3	Motor input

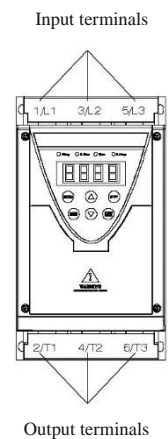

Figure 3-3 Input and output terminals

Control terminals of SFT50 soft starter as shown in Figure 3-4:



Figure 3-4 Arrangement of SFT50 soft starter control terminals

Control terminal function description:

SFT50 has 14 external control terminals for external signal control, remote control and system control, as shown in Table 3-5:

Table 3-5 External control terminals

Terminal number	Terminal name	Description
M <sup>2</sup> Bus	PIN1: COM	Isolated 12V output
	PIN8: Isolated 12V output	
	PIN4: 485-A	Modbus-RTU
	PIN5: 485-B	
C1/1	Analog output	Optional 4-20mA /0-10V
C2/2		
X1/3	Emergency stop	External emergency stop input terminal
X2/4	External control start terminal	X2/4 and COM /6 close to start
X3/5	External control stop terminal	X3/5 and COM/6 open to stop
COM/6	Common terminal	Logic input terminal
EAR/7	PE	Earthing
PA/8	Start relay	PA/PB closed after running output
PB/9		
TA/10	Fault output relay	Common terminal
TB/11		Fault output normally open terminal
TC/12		Fault output normally closed terminal
L/13	Input control circuit terminals	AC220V, 50Hz (optional 110V, 60Hz)
N/14		

Figure 3-6 shows the standard wiring diagram of SFT50 soft starter:

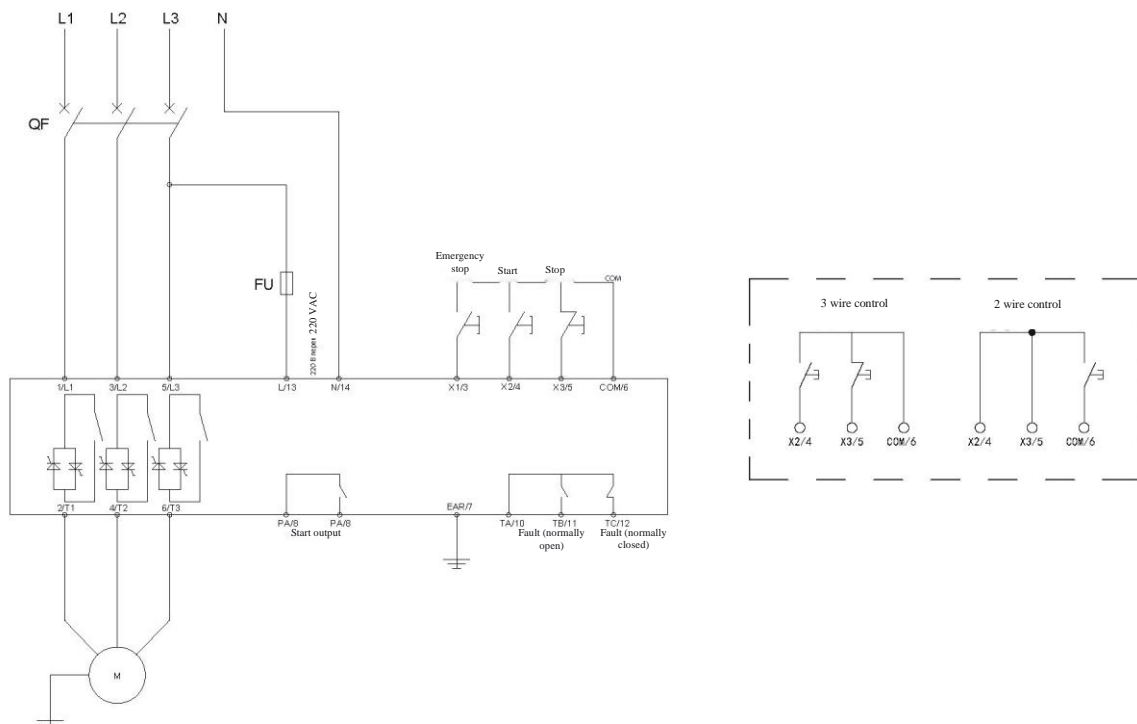

**Attention!**

1. SFT50 soft starters have two modes of start and stop control: panel, control terminal with two and three wires, two-wire control – hold signal, three-wire control – trip signal.
2. With the two-wire control, the panel control is invalid.
3. With the three-wire control, the panel control is valid.
4. X3 and COM must be kept closed for panel control.
5. The external button signal should remain valid for > 200 ms, and invalid for < 200 ms.

Figure 3-6 Standard wiring diagram of SFT50 soft starter

**3.2.3. Control Circuit Configuration and Wiring**

Figure 3-7 General structure of SFT50 soft starter

**Note:**

It is recommended to use a wire of 1 mm<sup>2</sup> or more as the terminal connection wire.

**3.2.4. Field Wiring and Grounding Requirements****1. Field Wiring Requirements:**

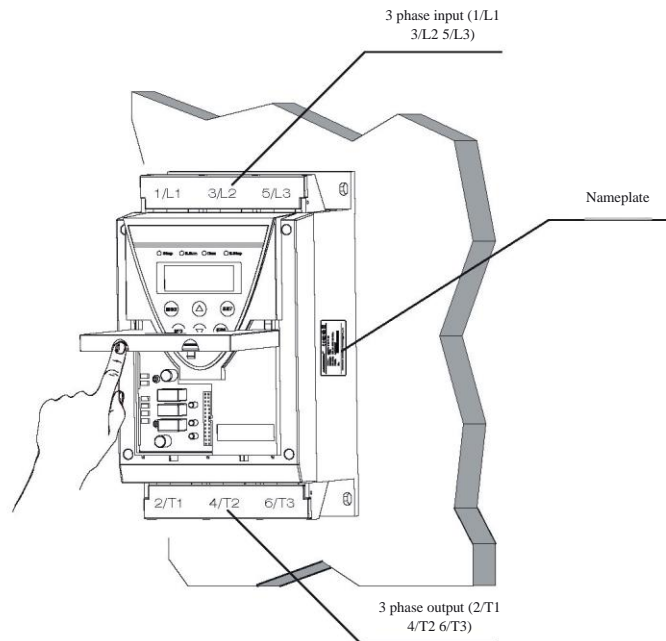
In order to avoid mutual coupling and interference during the operation of the equipment, control cables, power cables, and motor cables should be installed separately. Generally, there should be a sufficient distance between them and as far as possible, especially when the cables are installed in parallel and extend to long distance. When the control cable must pass through the power cable or the motor cable, keep the two vertically crossed, as shown in Figure 3-7.



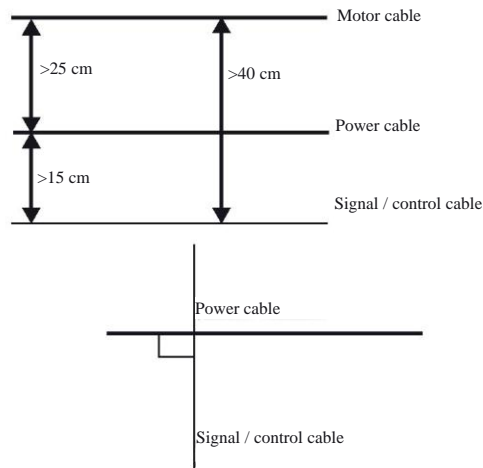

Figure 3-7 System wiring requirements

The power cable of the soft starter should be a cable with a specified cross-section. The control cable is generally a shielded cable, and the shielded metal braid should be connected to the ground terminal or ground point of the soft starter through the cable clamps at both ends.

2. Grounding Requirements:

Dedicated ground electrode (recommended), as shown in Figure 3-8a:

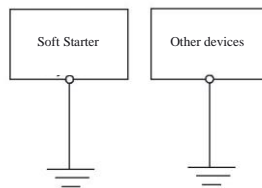

Figure 3-8a Grounding schematic 1

Common ground electrode (allowed), as shown in Figure3-8b:

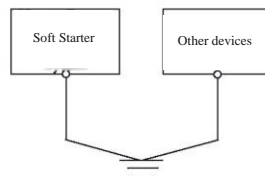

Figure 3-8b Grounding schematic 2

Common ground wire (not allowed), as shown in Figure3-8c:

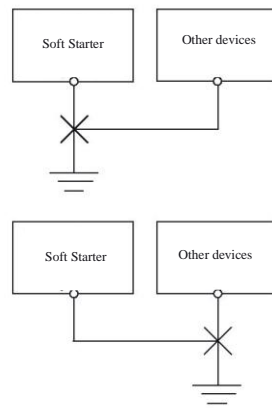

Figure 3-8c Grounding schematic 3

In addition, you should pay attention to the following:

- a) In order to ensure that the impedance of different grounding systems is as low as possible, the largest standard size of the grounding cable should be used as much as possible.
- b) It is better to use flat cables, because cables with the same cross-sectional area have a lower high-frequency impedance than flat conductors.
- c) One end of the grounding cable in the motor cable (4-core) between the motor and the soft starter is grounded on the soft starter side, and the other end is connected to the motor ground end; if the soft starter and the motor have a dedicated grounding end, the effect will be better.
- d) The grounding cable should be far away from the wiring of the third device, and the grounding point should be as short as possible, and should be as close to the soft starter as possible.

### 3.2.5. Safety Precautions

- 1) The soft starter should be installed in an environment that meets the requirements of the standard, and should be kept away from dangerous places with flammable gas, explosive gas or dust to prevent fire or explosion.
- 2) After the soft starter is powered on, it is forbidden to touch the internal electrical components and perform any inspection.
- 3) When connecting the power circuit of the soft starter, it must be de-energized.
- 4) Do not connect the power supply voltage exceeding the allowable fluctuation range to the soft starter, otherwise the device will be damaged.
- 5) Every time, check the circuit connection for errors, otherwise the soft starter will be damaged.
- 6) Make sure that the soft starter is safely grounded before running.
- 7) The control circuit wiring should be as far away as possible from the main power circuit cable to prevent malfunction due to interference noise.
- 8) If the control circuit is to cross a power circuit, the crossing should be made in a straight line; if the line to be connected is longer, twisted pair or shielded line should be used.

## Chapter 4 Soft Starter Operation Instructions

### 4.1 Terminology

The parameters of SFT50 are mentioned in this chapter. For details, please refer to Chapter 5 on page P19.

### 4.2 LCD Keypad Display Unit Description

SFT50 LCD display description is shown in Figure 4-1:

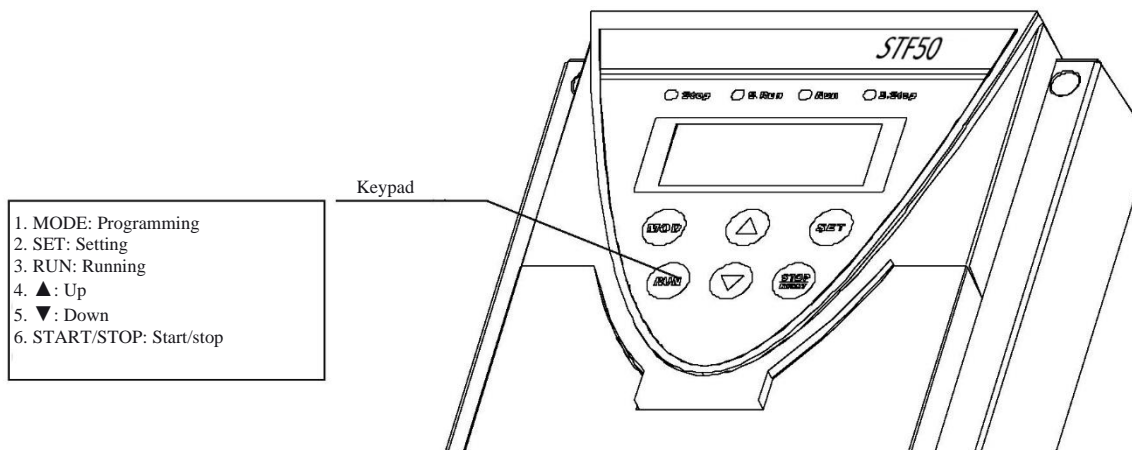

Figure 4-1 LCD keypad indication unit on the display and foretop

#### 4.2.1. Keypad Function Description

There are 6 keys on the operation panel, and the function definition of each key is shown in Table 4-1.

Table 4-1 Key functions

Key	Description	Functions
MODE	Programming	Enter and exit programming state
SET	Setting	Data write confirmation under parameter setting modification state
RUN	Running	When the keypad mode is valid, press this key to run the soft starter
▲	Up	Data and parameter are incremented; information screen group is switched up
▼	Down	Data and parameter are decremented; information screen group is switched down
STOP/RESET	Stop/reset	When the keypad mode is valid, press this key to stop the soft starter Return to initial screen when fault reset / parameter setting

If a fault occurs in SFT50 soft starter, four indicators flash simultaneously. Please perform troubleshooting before starting. Press the increment key (▲) or decrement key (▼) in each group of message screens. This will allow you to swipe the contents of each screen group up or down.

#### 4.2.2. Indicator Description

SFT50 operation panel has 4 indicators, stop indicator, soft start indicator, running indicator, soft stop indicator. The meaning of each indicator is shown in Table 4-2:

Table 4-2 Indicator function description

Indicator	Value	Indicator color	Sign
Stop	Light on, stopped	Red	Stop
Soft start	Light on, soft start state	Green	S.Run
Run	Light on, running	Green	Run
S.Stop	Light on, soft stop state	Red	S.Stop
All lights off	Light on, fault state	No	All lights off

 Note:

When an alarm occurs in the soft starter, all four indicators are off. Please perform troubleshooting before starting.

#### 4.2.3. Information Screen Introduction and Operation

The info of SFT50 screen has nine items: 1 - Average current; 2 - Phase A current; 3 - Phase B current; 4 - Phase C current; 5 - Input voltage; 6 - Output voltage; 7 - Module temperature; 8 - Alarm recording; 9 - Software version information. Power on the soft starter, enter the main information screen content after displaying the startup status screen, and you can view the information in sequence by pressing the increment key (▲) or decrement key (▼) to view the information in turn.

The information screen is shown in Table 4-3:

Table 4-3 Main information screen display table

Description	Screen display	Description		
screen	Average current	Motor terminal voltage display content is average current value		
	Phase A current	Display, phase A current		
	Phase B current	Display, phase B current		
	Phase C current	Display, phase C current		
	Output voltage	Motor terminal voltage display		
	Input voltage	The displayed content is the average voltage value of the detected three-phase voltage		
	Module temperature	The temperature value is the value detected by the soft starter temperature sensor to the thyristor radiator		
	Alarm record	0000	First alarm	One last alarm
		0000	Second alarm	Last two alarms
		0000	Third alarm	Last three alarms
0000		Fourth alarm	Last four alarms	
	The displayed code corresponds to page 30 of Chapter 6 Troubleshooting.			
Version information	The version information displayed on this screen is the version number of the operation display unit			

Press the increment key (▲) or decrement key (▼) in the operation panel to switch up or down in the screen content. Figure 4-2 shows the screen content switching operation process:

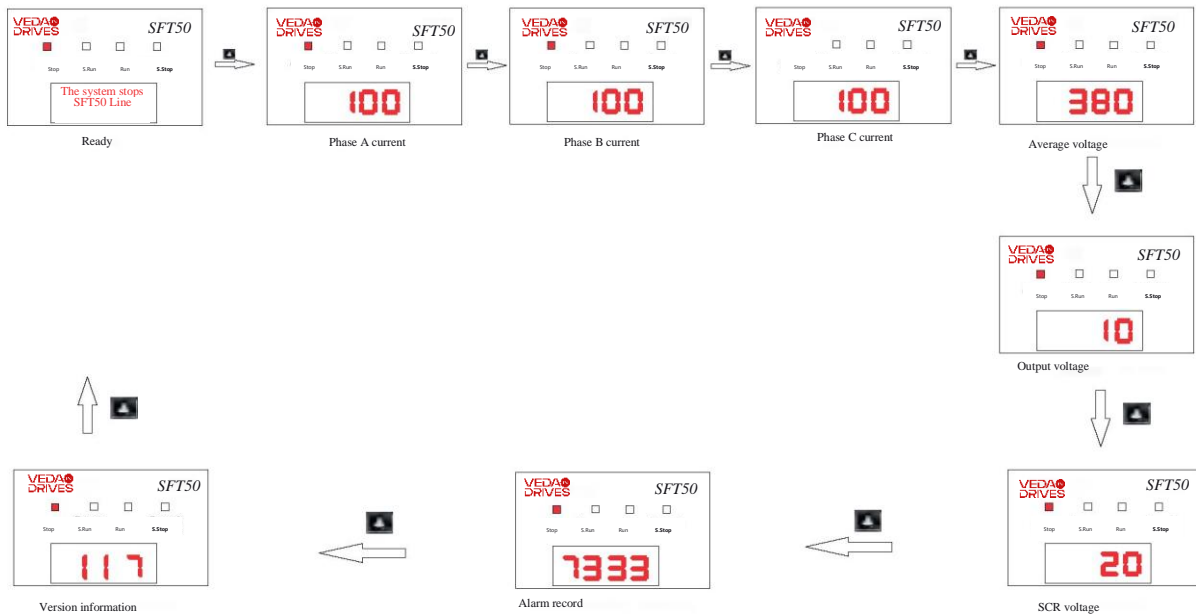

Figure 4-2 shows the screen content switching operation process

#### 4.2.4. Soft Starter Parameterization Process

##### 1) Soft Starter Parameterization Mode

SFT50 soft starter has a total of 36 parameters: F-00 ~ F-35. For example, 'F-00' is the first parameter.

##### 2) Menu Structure of Display Unit

When setting the parameter through the digital display unit, the parameter number corresponds to the first-level menu, and the parameter value corresponds to the second-level menu.

##### 3) Example of Parameter Setting

SFT50 soft starter adopts decimal representation. Each of them is independent when editing. The value range of some bits can be decimal (0-9). The parameter value has one, ten, one hundred, and thousand digits. Use the (Run) key to select the digit to be modified, and use the increase key (▲) or decrease key (▼) to increase or decrease the value. Take the parameter function menu to change the soft stop time from 10 s to 25 s (F-01 changed from 10 s to 25 s) as an example to explain the setting operation process, as shown in Figure 4-3:

Press MODE or RST to return

Figure 4-3 Operation flowchart:

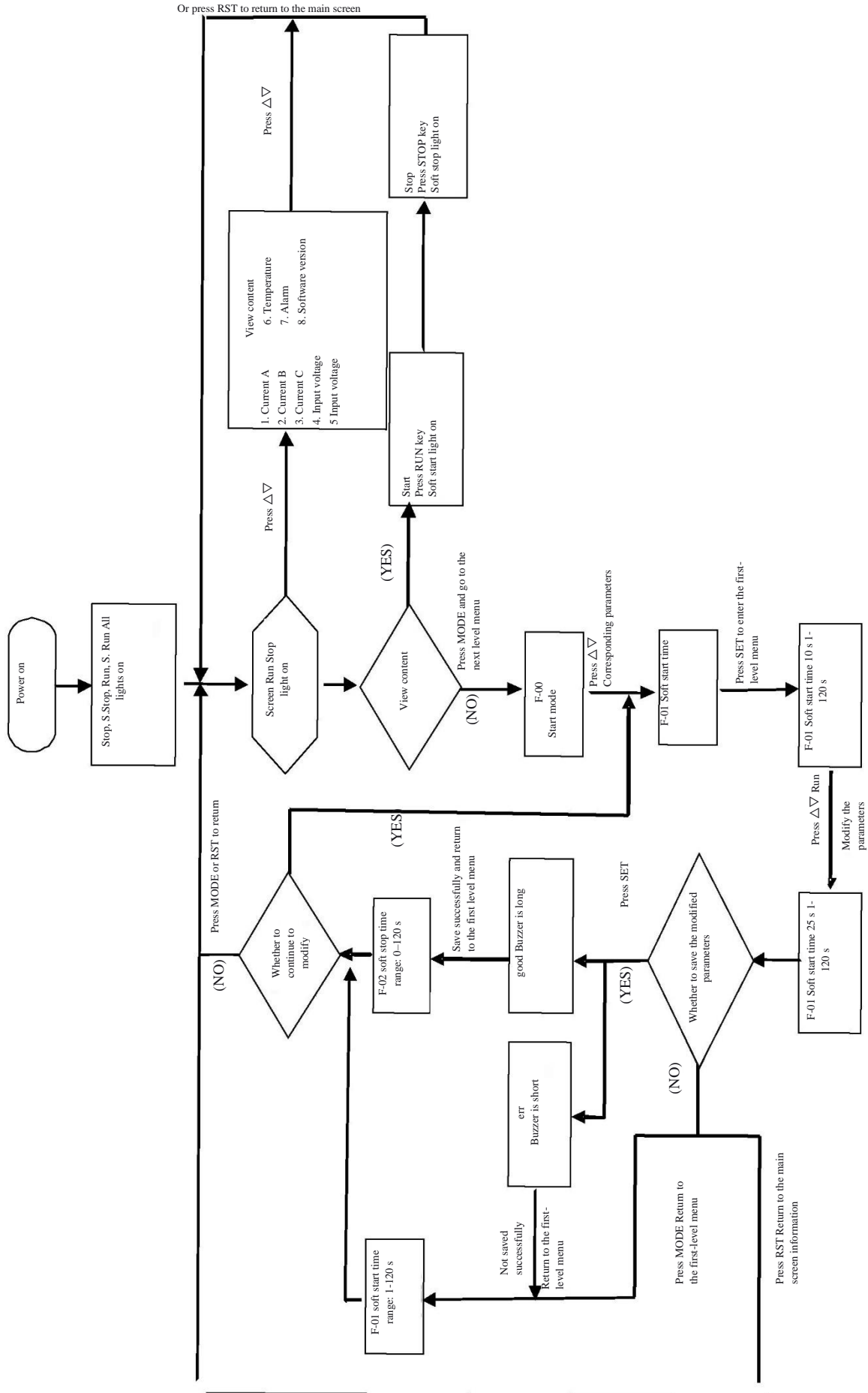

Note: When the power is on, the power indicator is always on.

Operation steps are as follows:

- 1) SFT50 soft starter is in the boot state, the status light 'Stop, S.Run, Run, S.Stop' is on;
- 2) Press the MODE key to enter the programming state and display the current parameter 'F-00';
- 3) Press the ▲ key until the digital tube displays the parameter 'F-01'.
- 4) Press the SET key to enter the 'F-01' parameter secondary menu, the flashing position is the first change position ('0' flashes):
- 5) Press the ▲ key five times to change the corresponding flashing digit from '0' to '5';
- 6) Press the Run key to move the flashing position to the second change position ('6' flashes);
- 7) Press the ▼ key four times to change the corresponding flashing digit from '6' to '2';
- 8) Press the SET key, 'good' is displayed and the buzzer is long and the data is saved successfully; if 'Err' is displayed and the buzzer is short, the data is not saved successfully. When the value of 'F-01' is saved, the next parameter is automatically displayed ('F-02' is displayed);
- 9) Press the MODE key to exit the programming state and return to the system main information screen display to complete the task of editing the specified parameters.

The screen of each step is shown in Figure 4-4:



Figure 4-4 Screen schematic diagram

## Chapter 5 Detail Function Description and Settings

This chapter mainly explains the functional parameters of SFT50 soft starter. According to the functions of the parameters, they are divided into 25 parameters, which are:

F-00: Start mode;

F-01 Soft start time;

- F-02: Soft stop time;
- F-03: Start-stop voltage;
- F-04: Current limit amplitude;
- F-07: Step voltage;
- F-08: Forced start time;
- F-09: Forced start interval;
- F-10: Forced start number;
- F-11: Run overcurrent;
- F-12: Overload protection;
- F-13: Overload mode;
- F-16: Overvoltage protection;
- F-17: Undervoltage protection;
- F-18: Output phase loss;
- F-19: Module overtemperature;
- F-20: Timeout protection;
- F-21: Imbalance;
- F-23: Delayed start;
- F-24: Communication address;
- F-25: Communication baud rate;
- F-26: Parity check
- F-29: Terminal X1 function
- F-30: Analog output;
- F-32: Initialization;
- F-33: Language selection;
- F-34: Motor current;
- F-35: Manufacturer password.

The parameter is described as follows:

Parameter	Description	Setting range	Default value
-----------	-------------	---------------	---------------

**5.0 Start Mode (F-00)**

F-00	Start mode	0-2	Default: 0
------	------------	-----	------------

- 0: Linearly variable current
- 1: Current limit
- 2: Linearly variable voltage

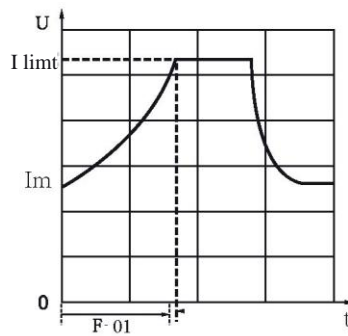

Figure 5-1 Initial voltage and time

The current in F-01 is the linearly variable voltage

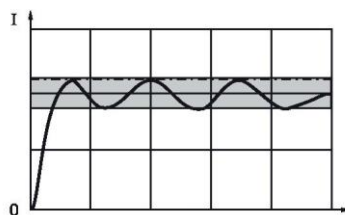

Figure 5-2 Current limit amplitude

The shaded area is the set current limit



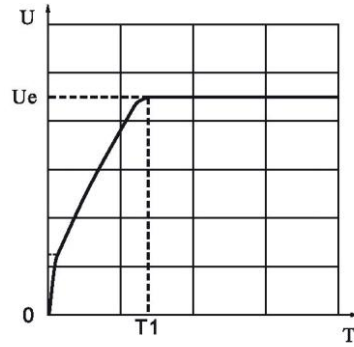

Figure 5-3 Linearly variable voltage

0-T1 is the linearly variable voltage

### 5.1 Soft Start Time (F-01)

F-01	Soft Start Time	Range: 1-120 s	Default: 10
------	-----------------	----------------	-------------

The soft start time is the time required from the start of the startup to the completion of the startup process.

In order to obtain the best start-stop effect, different starting voltages and times can be set for adjustment. See Figure 5-1 for start mode for details.

### 5.2 Soft Stop Time (F-02)

F-02	Soft Stop Time	Range: 0-120 s	Default: 0
------	----------------	----------------	------------

In order to enable the mechanical load to stop smoothly without generating secondary impact and to minimize mechanical and electrical damage, F-02 and F-03 can be combined to achieve a stable stop of the mechanical load, as shown in Figure 5-4. As shown:

 Note:

When the soft stop time is set to 0, the motor will stop freely.

### 5.3 Stop and Start Voltage (F-03)

F-03	Stop and Start Voltage	Range: 20-75% Ue	Default: 25
------	------------------------	------------------	-------------

The start-stop voltage refers to the voltage value at which the initial output voltage of the soft start and the output control voltage at the time of stopping are reduced to the minimum. In order to obtain the best start-stop effect, different start / stop voltages and times can be set to adjust. Set the percentage of the range value based on Ue.

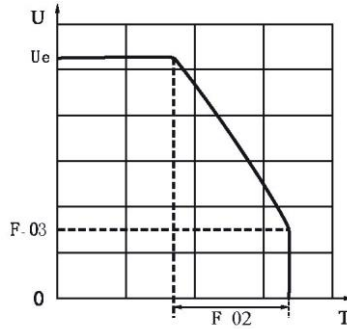

Figure 5-4 Stop voltage and time

Ue in the figure shows the stop voltage value, the soft stop time is determined by F-02.

### 5.4 Current Limit Amplitude (F-04)

F-04	Current limit	Range: 150–600% Ie	Default: 350
------	---------------	--------------------	--------------

Figure 5-5 Current limit amplitude diagram t

The starting current of the soft starter is limited to a setting range based on the rated current, as shown in Figure 5-5.

### 5.5 Forced Start Voltage (F-07)

F-07	Forced Start Voltage	Range: 20%~100%	Default: 100
------	----------------------	-----------------	--------------

F-08	Forced Start Time	Range: 0~500 T	Default: 0
------	-------------------	----------------	------------

Forced start time refers to the time of one forced start.

Unit: period (grid frequency)

Note:

When set to 0, the forced start time is turned off.

F-09	Forced Start Interval	Range: 0~50 T	Default: 0
------	-----------------------	---------------	------------

The forced start interval is the time between two forced starts.

During the forced start interval meter, the thyristor is turned off without output. Unit: period (grid frequency).

Note:

When set to 0, the forced start interval is turned off.

F-10	Forced Start Time	Range: 0~100	Default: 0
------	-------------------	--------------	------------

Note:

When set to 0, the forced start interval is turned off.

### 5.6 Run Overcurrent (F-11)

F-11	Run Overcurrent	Range: 0~400% Ie	150
------	-----------------	---------------------	-----

The soft starter detects that the running current exceeds the set value of F-11 during the running process. After the duration reaches T, the system makes an overcurrent protection action stop and displays an overcurrent alarm, as shown in Figure 5-6

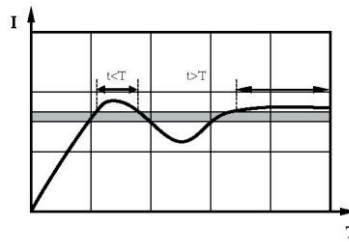

Figure 5-6 Overcurrent protection

Note:

When set to 0, no overcurrent protection is performed.

When the overcurrent time t is less than the set overcurrent detection time T, overcurrent protection is triggered.

When the overcurrent time t is greater than the set overcurrent detection time T, an alarm is issued.

### 5.7 Overload Protection (F-12)

F-12	Overload Protection	Range: 0-4	Default: 3
------	---------------------	------------	------------

Select different protection levels according to the load of the soft starter. Table 5-1 shows the corresponding current multiples and trip times of different levels.

Overload protection level 1 is light load, level 2 is light load, level 3 is standard and level 4 is heavy load.

Timer / Delay Time / Operating Current / Overload Current	1	2	3	4
1.2	40~60 s	1~2 m	2~3 m	3~6 m
1.5	20~40 s	20~40 s	1~1.5 m	1.5~3 m
4	2~5 s	5~8 s	8~11 s	11~20 s
6	1~2 s	2~4 s	4~5 s	4~8 s

Table 5-1 Overload level current multiple and trip time

When the running current value exceeds the current multiple of the corresponding protection level, it will act within this protection level trip time, and the protection level coefficients are downward compatible. The overload level curve is shown in Figure 5-7.

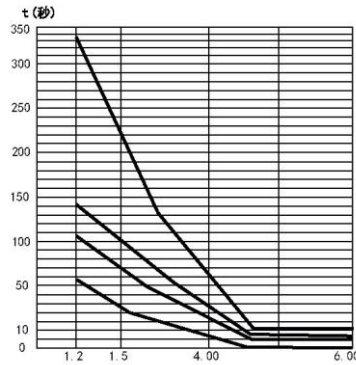

Figure 5-7 Overload level curve

F-13	Overload Mode	Range: 0-1	Default: 0
------	---------------	------------	------------

0: Soft start, the running process is valid.

1: The running process is valid.

**5.8 Overvoltage Protection (F-16)**

F-16	Overvoltage Protection	Range: 0-1000 V	Default: 480
------	------------------------	-----------------	--------------

In case of excessive voltage in the three-phase network, the soft starter determines whether the voltage value exceeds the F-16 setpoint and, after the system alarm time has elapsed, activates the overvoltage protection and the alarm.

Note:

When the overvoltage protection setting value is 0, the overvoltage protection does not work.

**5.9 Undervoltage Protection (F-17)**

F-17	Undervoltage Protection	Range: 0-1000 V	Default: 280
------	-------------------------	-----------------	--------------

The soft starter performs protection operation when it detects that the input three-phase voltage is lower than the set value.

When it is lower than the set value of F-17 function code and continues to exceed the set time, the soft starter performs undervoltage protection and alarms.

Note:

When the undervoltage protection setting value is 0, the soft starter does not perform under voltage protection operation.

**5.10 Output Phase Loss (F-18)**

F-18	Output Phase Loss	Range: 0~30	Default: 5
------	-------------------	-------------	------------

0: off

Others: If there is less than setting% Ie in three phases, it is lack of phase and undercurrent.

### 5.11 Module Overtemperature (F-19)

F-19	SCR Overtemperature	Range: 0–90 °C	Default: 85
------	---------------------	----------------	----------------

The soft starter detects that the temperature of the module is higher than the set value of F-19, and performs protection operation after continuously exceeding the set time

 Note:

When the module overtemperature protection setting value is 0, the soft starter does not perform overtemperature protection operation.

### 5.12 Timeout Protection (F-20)

F-20	Timeout Protection	Range: 0–120 s	Default: 20
------	--------------------	----------------	----------------

During the start of the soft starter, when the time of the start process exceeds the value set by this parameter, it will output a timeout alarm.

 Note:

When set to 0, no timeout protection is performed.

### 5.13 Imbalance (F-21)

F-21	Imbalance	Range: 0–100%	Default: 50%
------	-----------	---------------	--------------

Based on % I<sub>e</sub>, three-phase current within the range If the current value is greater than the set value I<sub>e</sub>, the system will alarm.

 Note:

When set to 0, imbalance protection is not performed

### 5.14 Communication (F-23–F-29)

F-23	Delayed Start	Range: 0~60 s	Default: 0
------	---------------	---------------	------------

F-24	Communication Address	Range: 0~255	Default: 1
------	-----------------------	--------------	---------------

F-25	Communication Baud Rate	Range: 0~2	Default: 0
------	-------------------------	------------	------------

0:4800 bps

1:9600 bps

2:19200 bps

F-26	Parity Check	Range: 0~2	Default: 0
------	--------------	------------	------------

0: No check

1: Imparity check

2: Parity check

F-29	Terminal X1 Function	Range: 0~255	Default: 0
------	----------------------	--------------	------------

0: Disabled

1: Reset

2: Emergency stop

### 5.15 Analog Output (F-30)

F-30	Analog Output	Range: 0~9999	Default: 0
------	---------------	---------------	------------

0: off

Others: Set current corresponding to analog 20mA output

### 5.16 Initialization (F-32)

F-32	Initialization	Range: 0-2	Default: 0
------	----------------	------------	------------

0: Deactivated

1: Reset

2: Clear alarm records

### 5.17 Language Selection (F-33)

F-33	Language Selection	Range: 0:1	Default: 0
------	--------------------	------------	------------

0: Chinese

1: English

### 5.18 Motor Current (F-34)

F-34	Motor Current	Range: 1~9999A	Default: 11A
------	---------------	----------------	--------------

Motor rated current.

### 5.19 Factory Password (F-35)

F-35	Factory Password	Range: 0~9999	Default: ****
------	------------------	---------------	------------------

The factory password is only used by the manufacturer to set. The end user does not need to set it.

## Chapter 6 Troubleshooting



Warning/Danger

- Troubleshooting and maintenance should only be performed after the soft starter display (LCD or status indicator) goes out and it is confirmed that the bus voltage is below 36 V; otherwise, personal injury, electric shock, fire, and other hazards may result.

SFT50 soft starter not only reflects superior performance when starting and stopping, but also accurate and reliable in product protection. SFT50 soft starter has various safety functions for comprehensive protection of the motor and traction equipment, in particular phase failure, overvoltage, underpressure, overtemperature, imbalance, overload, overcurrent and external input fault. When the system detects an alarm, the corresponding alarm information is displayed on the LCD screen. The types of faults and how to rectify them are shown in the following table:

Error alarm Type of indication	Possible cause	Solutions	Status			
			Soft start	Running	S.Stop	Stop
X3 and COM are not connected	External control terminals X3 and COM are not connected during panel control.	Connect external control terminal X3 and COM correctly				√
Er01 Run Overcurrent	During operation, when the measured current > F-04 (current limit), the system generates an alarm during operation.	<ol style="list-style-type: none"> <li>1. Check whether the motor model is consistent with the nameplate of the soft starter: whether the rated power, the voltage is consistent, whether the rated power exceeds the rated power of the nameplate of the soft starter. If so, restore the match and try again.</li> <li>2. Check whether there is a short circuit or grounding phenomenon between the motor and the soft starter.</li> <li>3. Check for an overload.</li> <li>4. Increase the setting value of F-11.</li> <li>5. Check part of the application setting and whether the load type is within the scope of the soft starter.</li> <li>6. Turn off the overcurrent protection function and change F-11 settings to 0.</li> </ol>		√		
Er02 Module Overtemperature	When the system monitors the temperature of module in F-19 through the sensor, the system gives the overtemperature alarm.	<ol style="list-style-type: none"> <li>1. Check whether the ambient temperature is too high (if there is direct sunlight, whether it is installed in the closed environment), resulting in the temperature of the radiator module in the soft starter can not drop in time, exceeding the set value of the parameter (F-19) overtemperature protection, the corresponding cooling treatment (such as air cooling or shutdown cooling treatment).</li> <li>2. Check if there is no heat source (e.g. electric oven, heater, etc.) near the soft starter, remove the heat source and use the soft starter.</li> <li>3. If the soft starter starts and stops frequently in a short time, the internal power device will be in a high current running state, and the radiator module will be overheated. Please wait for a period of time (&gt; 5 minutes) until the radiator module cools down before operating.</li> </ol>	√	√	√	
Er03 Start Timeout	During the motor start-up process, when the device does not accelerate to full speed (namely to the operating state) in the F-20 time during the start-up period, the system outputs an alarm signal.	<ol style="list-style-type: none"> <li>1. Check whether the rated power of the motor does not exceed the rated power of the soft starter.</li> <li>2. Check the load value and increase the soft start time.</li> </ol>	√			

Error alarm Type of indication	Possible cause	Solutions	Status			
			Soft start	Running	S.Stop	Stop
Er04 System Phase Loss	The system has a three-phase power supply, any phase is missing, not connected, or the output end to the motor is missing, the system will generate an alarm.	<ol style="list-style-type: none"> <li>1. Check for phase loss at the input.</li> <li>2. Check the contact between the three-phase power supply and the soft starter.</li> <li>3. Check the connection between motor to soft starter for disconnection.</li> <li>4. Check the connection between motor to soft starter for poor contact or ground fault.</li> </ol>	√	√	√	
Er05 Overvoltage	When the system detects that the mains voltage is > the F-16 setpoint, the system will generate an alarm.	<ol style="list-style-type: none"> <li>1. Check whether the input three-phase voltage exceeds the overvoltage protection value set in parameter (F-16). If the set value is exceeded, switch off the mains and wait until the mains voltage returns to normal (below the overvoltage protection value set in parameter (F-16)).</li> <li>2. Check the mains voltage level.</li> <li>3. This protection does not work when parameter (F-16) is set to 0.</li> </ol>	√	√	√	√
Er06 Undervoltage	The mains voltage is < F-17 set value and the system generates an alarm.	<ol style="list-style-type: none"> <li>1. Check whether the mains voltage is below the undervoltage protection value set in parameter (F-17). If it is below the set value, switch off the mains and wait until the mains voltage returns to normal (above the undervoltage protection value set in parameter (F-17)).</li> <li>2. Check the mains voltage level.</li> <li>3. This protection does not work if F-17 is set to 0.</li> </ol>	√	√	√	
Er07 Overload Protection	When the running current reaches the overload level set by F-12, the system generates an alarm (see the corresponding overload protection curve).	<ol style="list-style-type: none"> <li>1. Check whether the motor power exceeds the rated power of the soft starter. If so, restore the match and try again.</li> <li>2. Check whether the load on the motor is too high, and whether the load changes during operation.</li> <li>3. The value of F-12 parameter to change the overload protection curve of the system to operate the unit in the normal zone.</li> <li>4. Change F-12 setting to 0 and disable the system overload protection function.</li> </ol>	√	√		
Er08 Voltage Imbalance	When the difference between the maximum and minimum running current reaches the product of F-21 set value and the rated current, the system will generate an alarm within a certain time.	<ol style="list-style-type: none"> <li>1. Check the motor for aging</li> <li>2. Check whether the three-phase input voltage is unbalanced.</li> <li>3. Check whether the power supply input and output wiring is secure.</li> </ol>	√	√	√	

## Chapter 7 Maintenance and Repair

Due to the influence of environmental temperature, humidity, dust and vibration, aging and wear inside the soft starter, will lead to the potential failure of the soft starter, it is necessary to carry out daily and regular maintenance and repair of the soft starter.



 Note:

Before inspection and maintenance, first confirm that the soft starter has cut off the power supply and the power indicator light is off, otherwise the risk of electric shock will occur.

## 7.1 Product Servicing and Inspection

The soft starter must operate according to the operating environment specified in this manual. In addition, incidents may occur during operation, so users should perform the following daily maintenance to maintain normal operating conditions. This is a good way to extend the life of the soft starter and to detect signs of malfunction in time. See Table 7-1:

Table 7-1 Daily inspection tips

Object inspection	Necessary inspection		Assessment criteria
	Content inspection	Inspection tools	
Conditions of use	Temperature Humidity	Thermometer Humidometer	-10 °C to + 40 °C, if the temperature exceeds 40 °C, improved cooling is necessary
	Dust, water and drips	Visually	No water leaks
	Vibration	Vibration sensor	Less than 5.9 m / s (0.6g)
	Gas	Sniff	Odorless
Soft Starter	Heat	Pin	Smooth, normal air
	Sound	Listen	No abnormal sound
	Output current	Current clamp meter	In the rated range
	Output voltage	Voltmeter	In the rated range
Motor	Heat	Shell	No abnormal temperature rise
	Sound	Listen	No abnormal sound

## 7.2 Regular Maintenance

Depending on the operating conditions, the user can perform regular product inspections every 3 or 6 months.

 Note:

- 1) The personnel responsible for maintenance must have professional training.
- 2) Do not leave metal parts in the soft starter to avoid damage to the equipment.

General inspection:

- 1) Whether the screws of the control terminals are loose, tighten them with a screwdriver;
- 2) Whether the main circuit terminals are badly connected; whether there are overheating marks on the screw position.
- 3) Whether the power cables and control cables are damaged, especially whether there are cuts on the skin that is in contact with the metal surface;
- 4) Whether the insulation bandage of the power cable nose has come off;
- 5) Clean the dust on the circuit board and air duct thoroughly. It is best to use a vacuum cleaner.
- 6) The soft starter stored for a long time must be powered on once within half a year. When the power is on, the voltage regulator is slowly raised to the rated value, for nearly 5 hours, and can be carried out without load.

7) In the insulation test of the soft starter, all the input and output terminals must be short circuited to test the protective area. It is strictly prohibited to test the single terminal, otherwise there is a risk of damage to the soft starter.

8) If the motor is tested for insulation, the connection between the motor and the soft starter must be disconnected, and the motor must be tested separately, otherwise the soft starter will be damaged.

 Note:

The withstand voltage test has been passed before leaving the factory. The user does not need to perform withstand voltage test, otherwise the device will be damaged.

### 7.3 Soft Starter Storage

After purchasing the soft starter, the following must be taken into consideration when storing the device temporarily and for long periods of time:

1) Avoid storage in places with high temperature, humidity, and dust or metal dust. Keep the storage environment well ventilated.

2) Long-term storage will cause the deterioration of electrolytic capacitors. It must be ensured that it is energized once within 2 years, and the energization time is at least 5 hours. The input voltage must be slowly increased to the rated value with a voltage regulator.

### 7.4 Product Warranty

The quality guarantee of this product shall be subject to the following provisions

Quality assurance rules:  
This product is warranted for two years from the date of manufacture. Twenty-four full months warranty

(1) The company's soft starter comes with a lifetime paid service at any location.

(2) If the fault is caused by the following reasons, the company shall provide the paid repair service during the warranty period:

① Problems caused by incorrect operation (subject to this user manual) or self-repair and modification without permission

② Problems caused by the use of a motor soft starter beyond the standard specification requirements

③ Damage resulting from improper handling or storage

④ Device aging or failure caused by the environment

⑤ Damage caused by earthquake, fire, flood, lightning strike, abnormal voltage or other natural disasters

⑥ Intentionally damaged nameplate, mark and production serial number of the motor soft starter, which can not be identified separately

(3) In the event of quality problems or product failure, the company's liability is limited to the scope of the quality guarantee in this chapter.



## Disposal

- a. The electrolytic capacitor of the main circuit and the electrolytic capacitor on the printed board may explode when incinerated.
- b. Toxic gas will be generated when plastic parts such as the front panel and the plastic case are incinerated.
- c. Please dispose as industrial waste.

Appendix 1: Application Example Diagram

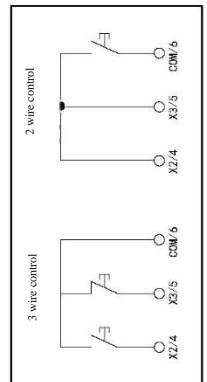
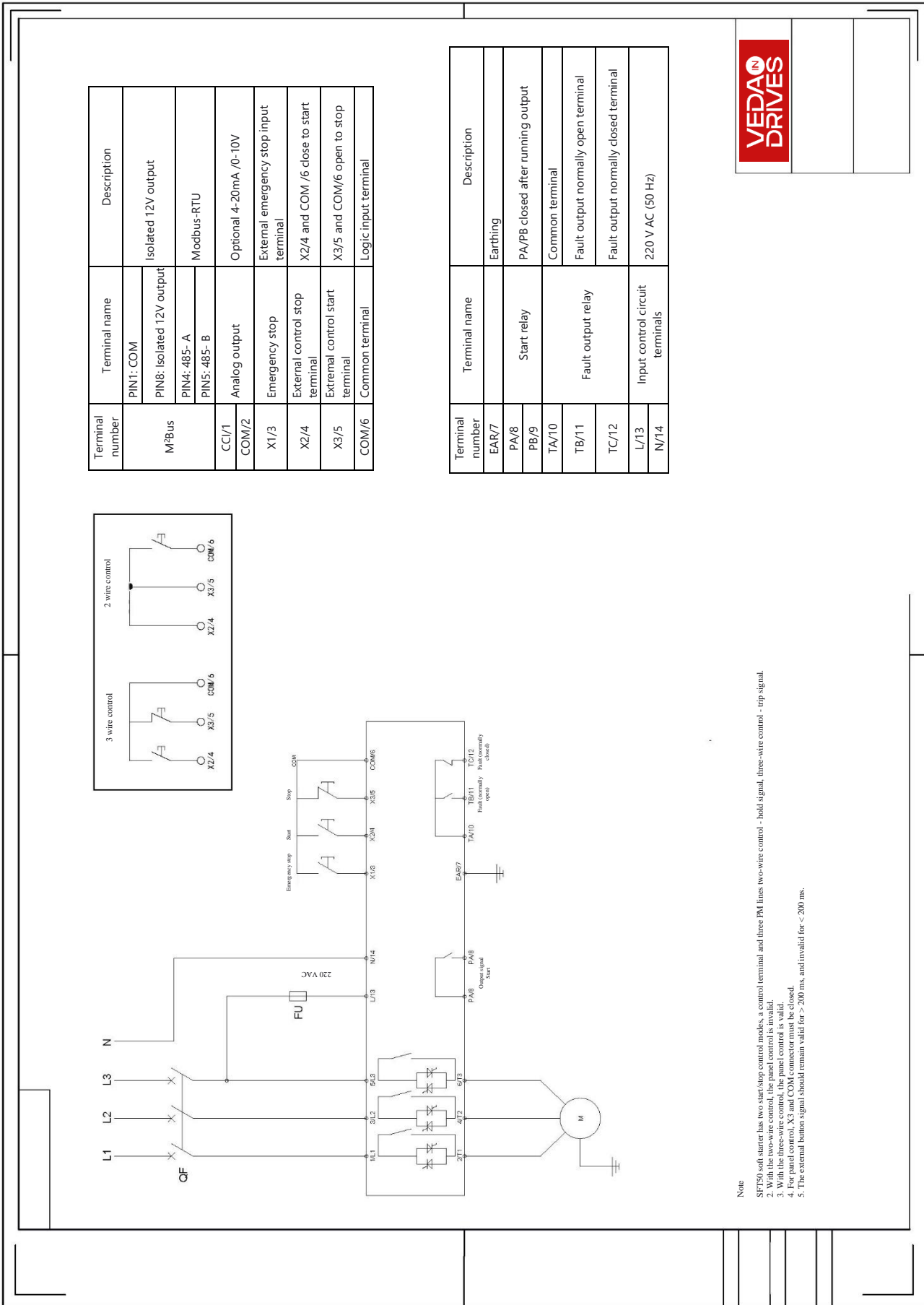

Terminal number	Terminal name	Description
M²Bus	PIN1: COM	Isolated 12V output
	PIN8: Isolated 12V output	
	PIN4: 485- A	
	PIN5: 485- B	
CCI/1	COM/2	Optional 4-20mA /0-10V
	X1/3	External emergency stop input terminal
X2/4	External control stop terminal	X2/4 and COM /6 close to start
X3/5	External control start terminal	X3/5 and COM/6 open to stop
COM/6	Common terminal	Logic input terminal

Terminal number	Terminal name	Description
EAR/7	Earthing	Earthing
PA/8	Start relay	PA/PB closed after running output
PB/9		Common terminal
TA/10		Fault output normally open terminal
TB/11	Fault output relay	Fault output normally open terminal
TC/12		Fault output normally closed terminal
L/13	Input control circuit terminals	220 V AC (50 Hz)
N/14		



Note

- SFT50 soft starter has two start/stop control modes, a control terminal and three PM lines two-wire control - hold signal, three-wire control - rmp signal.
- With the two-wire control, the panel control is invalid.
- With the three-wire control, the panel control is invalid.
- For the three-wire control, X3 and COM must be closed.
- The external button signal should remain valid for > 200 ms, and invalid for < 200 ms.

Appendix 2: Dimensional Drawing

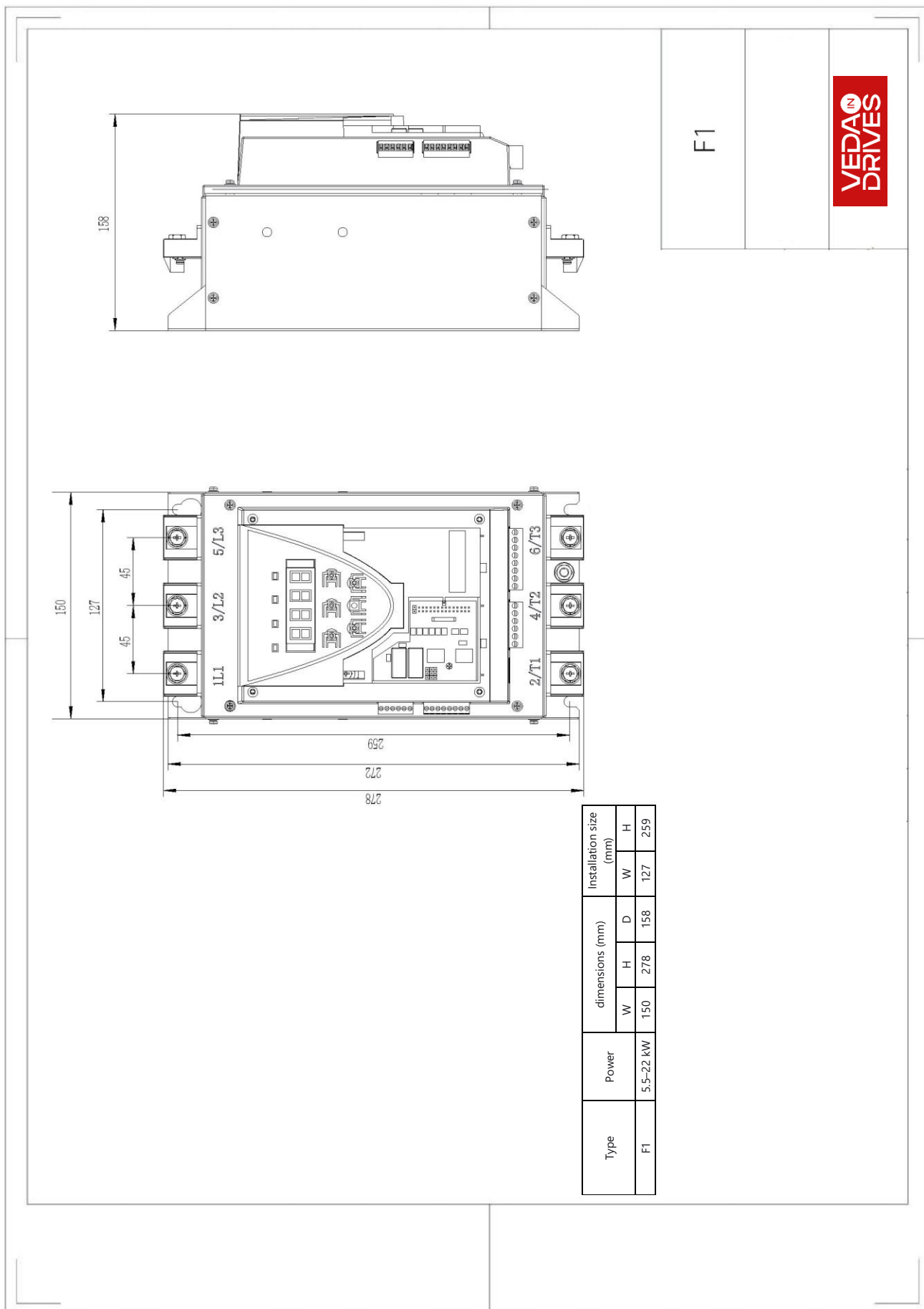

F2

Type	Power	dimensions (mm)			Installation size (mm)		
		W	H	D	W	H	H
F2	30-45 kW	180	350	177	75	320	320

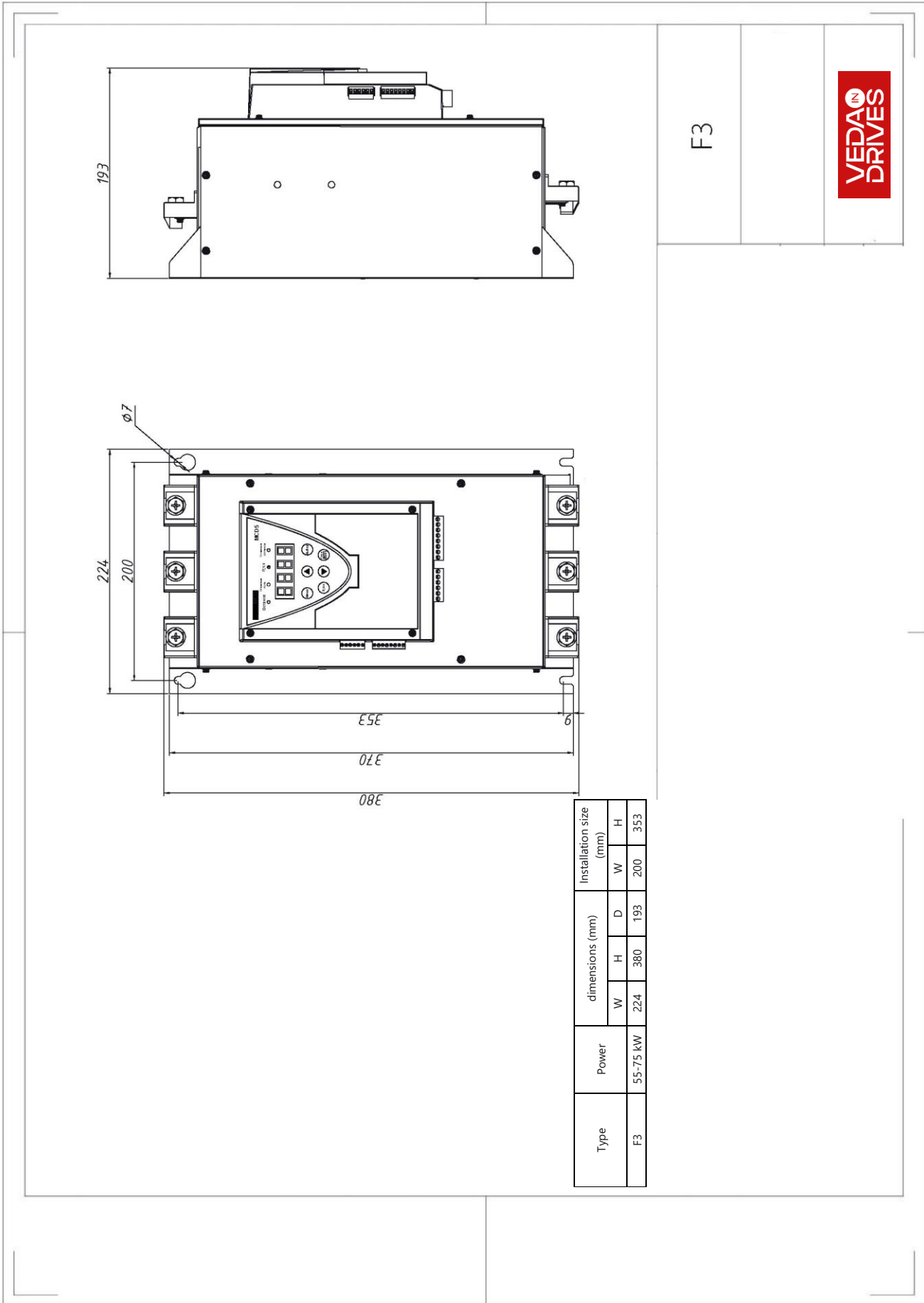

Type	Power	dimensions (mm)			Installation size (mm)	
		W	H	D	W	H
F3	55-75 kW	224	380	193	200	353

F3



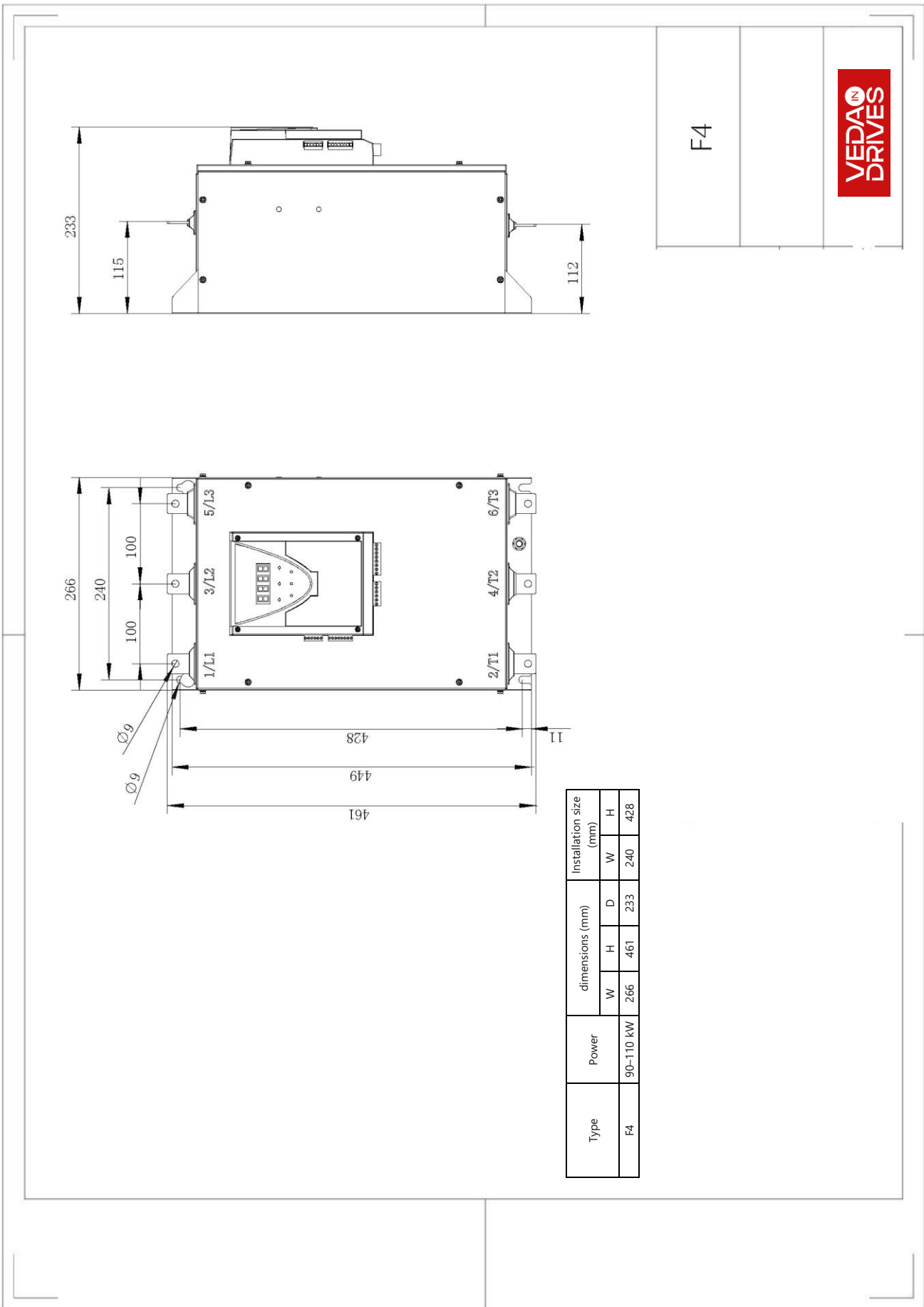

Type	Power	dimensions (mm)			Installation size (mm)		
		W	H	D	W	H	H
F4	90-110 kW	266	461	233	240	428	428

F4





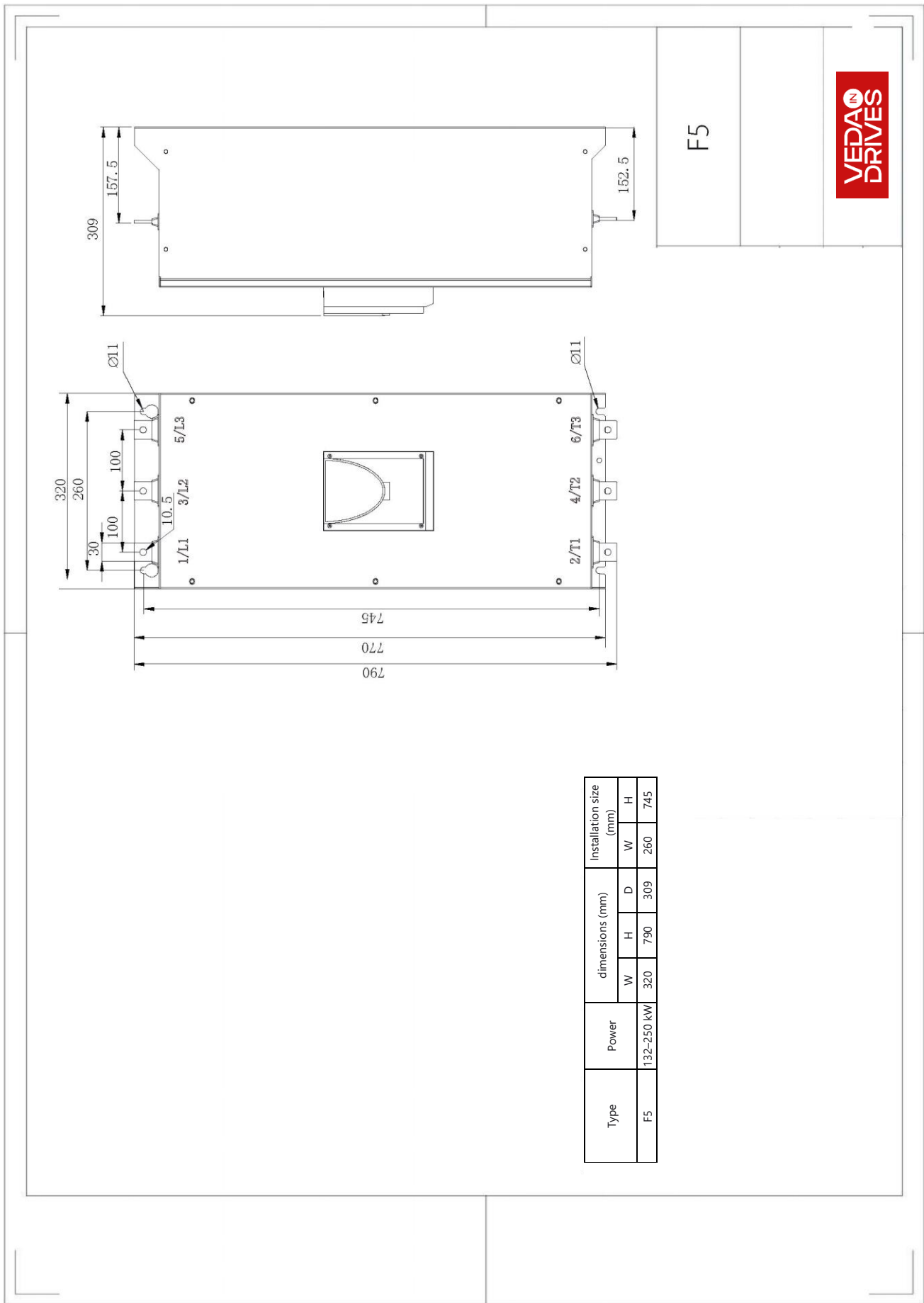

Type	Power	dimensions (mm)			Installation size (mm)		
		W	H	D	W	H	H
F5	132-250 kW	320	790	309	260	745	745

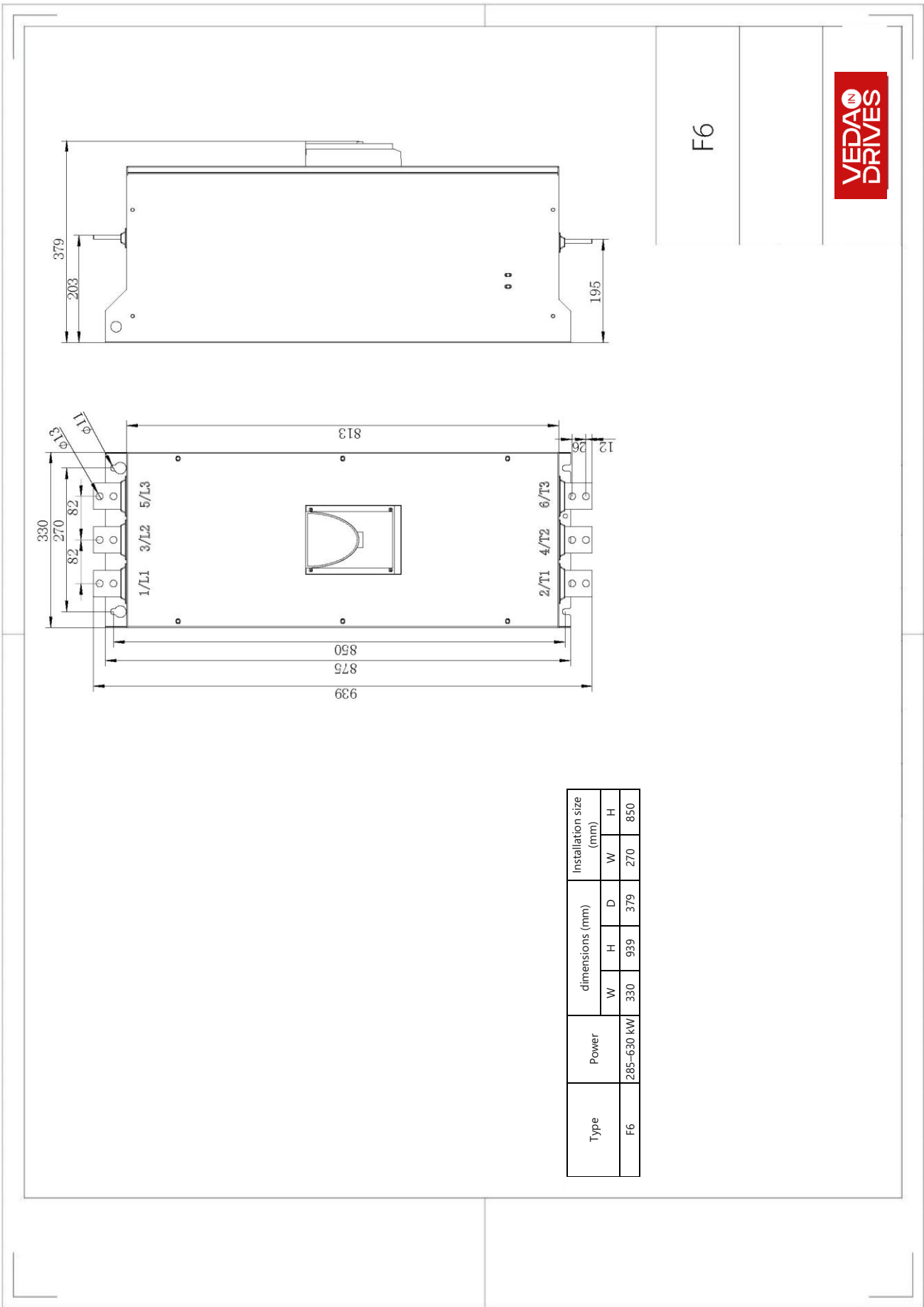

F6



Type	Power	dimensions (mm)			Installation size (mm)		
		W	H	D	W	H	H
F6	285-630 kW	330	939	379	270	850	850

VEDA-IN DRIVES has tested and verified the information contained in this manual.

In no event shall VEDA-IN DRIVES be liable for direct, indirect, special, incidental or consequential damages resulting from the use or misuse of the information contained in this manual.

Dated 10.05.2023

© VEDA-IN DRIVES