

# VEDA<sup>IN</sup>DRIVES

## MV SFT

### Medium-voltage Soft Starter

**Instruction Manual**



## **Safety**

- Read this manual carefully before operating the equipment and follow the instructions.
- Installation, operation and maintenance should be strictly accordance with this manual, national codes and good practice. Installation or operation not performed in strict accordance with these instructions will void manufacturer's warranty.
  
- Disconnect all power inputs before servicing the soft-starter and/or the motor.
- After installation, check and verify that no parts (bolts, washers, etc) have fallen into the power Section (IP00).

## **Attention**

- This product was designed for compliance with IEC 947-4-2 for class A equipment.
- For further information see Technical Specification

## **Warnings**

- Internal components and P.C.B's are at main potential when the VEDA-IN MV SFT is connected to main voltage. This voltage is extremely dangerous and will cause death or severe injury if contacted.
- When VEDA-IN MV SFT is connected to the main voltage, even if control voltage is disconnected and motors is stopped, full voltage may appear on starter's output and motor's terminals.
- Unit must be grounded to ensure correct operation, safety and prevent damage.
- Check that Power Factor capacitors are not connected to the output side of the soft starter and confirm that they are connected upstream to the line contractor

**The company reserves the right to make any improvements  
Or modifications to its products without prior notice**

# Table of Contents

---

<b>Page</b>	<b>Subject</b>
3	Starter Selection
4	Installation
5	Internal Setting
9	Control Terminals
11	Control Terminals – Option Boards
12	Control Wiring
14	Wiring Diagrams
15	Wiring Diagrams Diesel Generator
16	Wiring Diagrams – Communication
18	Start & Stop Parameters
20	Motor And Starter Protection
22	Motor And Starter Protection Occurrence Table
24	Front Panel
25	Display Mode
26	Parameter Settings
32	Low voltage test (with 400 V motor)
33	Start-Up Procedure
34	Menu Description
37	Trouble Shooting
39	Technical Specification

## Starter Selection

---

The VEDA-IN MV SFT is a highly sophisticated and reliable starter designed for use with standard medium voltage three-phase, three-wire, squirrel cage induction motors. It provides the best method of reducing current and torque during motor starting.

The VEDA-IN MV SFT starts the motor by supplying a slowly increasing voltage to the motor, providing soft start and smooth acceleration, while drawing the minimum current necessary to start the motor.

The second generation, microprocessor based digital circuitry provides unique features like pump control, accurate motor protection and optional analog output.

The optional RS485 Communication with MODBUS protocol enables full control (Start, Stop, Dual Adjust, command, etc.) and supervision. Up to 32 starters can be connected on a shield twisted pair to a host computer.

### Motor Current & Starting Conditions

Select the starter according to motor's Full Load Ampere (FLA) – as indicated on its nameplate (even if the motor is not fully loaded).

The VEDA-IN MV SFT is designed to operate under the following conditions:

- Max. ambient temp: 50°C
- Max. starting current: 400% motor's FLA
- Max. starting time: 30 sec. (at 400% FLA)
- Max. starts per hour: 2 starts per hour at

### PIV (Peak Inverse Voltage) Ratings

PIV Rating will be not less than:

<u>System Voltage</u>	<u>PIV Ratings</u>
2300V	6900V
3300V	9900V
4160V	12500V
6900V	19500V
10000V	26000V

### Main Voltage (line to line)

Thyristors PIV rating, internal circuitry and insulation defines the following voltage levels:

- \* 2300V \*3300V \* 4160V \* 6900V
- \*10000V

Each starter is suitable for 50/60Hz.

### Control Voltage

The Control voltage operates the electronic circuitry. The following voltage levels are available:

- 220-240V + 10%-15%, 50/60 Hz (standard)
- 110-120V + 10%-15%, 50/60 Hz
- 110 VDC (optional)
- Consult factory for special voltages.

### Control Inputs

Control Input voltage (start, stop, etc.) can be the same as Control Supply above (standard), or 24-240V AC / DC (by special order).

### Options (see Ordering Information Data)

- RS485-Modbus RTU
- RS485-Profibus DP
- Analogue output
- Touchscreen
- Isolation testing
- Linear acceleration/deceleration.

# Installation

---

## Preparation to Installation

Check that Motor Full Load Ampere (FLA) is lower than or equal to the starter Full Load Current (FLC) and that the Main and Control voltages are as indicated on the front panel.

## Mounting

- The starter must be mounted vertically.
- Do not mount the starter near heat sources.
- Protect the starter from dust and corrosive atmospheres.

**Note:** For severe environment, it is recommended to order the starter with Option # 8 – Special Treatment (PCB special varnish coating).

## Temperature Range and Heat Dissipation

The starter is rated to operate within the temperature range of -10°C (14°F) to + 50°C (122°F).  
Relative humidity inside the enclosure should not exceed 95% non-condensed .

Do not interchange line load connections.

## Short Circuit Protection

Protect the starter against a short circuit by the Thyristor Protection Fuses (see appendix page 37 for  $I^2t$  and fuses).

## Transient Protection

When high transients are expected, external protection should be used (consult factory).

## Power Section Connections

- **Line** to terminals L1, L2 and L3.
- **By-pass** to terminals L1b, L2b and L3b.
- **Motor** to U, V and W.
- Line and By-pass contactors must be used.
- Do not connect any devices between the Line Contactor and the VEDA-IN MV SFT.
- Power Factor Capacitors, if required, should be installed on the VEDA-IN MV SFT line side only (not on the VEDA-IN MV SFT Load side).
- Main supply must be applied in the correct phase sequence.
- Bus bars, C/T and bypass contactor must be arranging to maintain current flow through the bypass after end of acceleration process.
- Interlock the serial contactor - starting relay with the “Fault relay” of the VEDA-IN MV SFT.

### WARNING

Power factor correction capacitors, if required must be installed on the line side of the VEDA-IN MV SFT

Do not connect three phase voltage without starting the VEDA-IN MV SFT.

### WARNING

**When Installing into switch gear!!!**

**Do not** perform “**Hi-Pot**” test on the switchgear after the soft-starter has been installed in it. It will **damage** the VEDA-IN MV SFT.

## Internal Settings

---

**Control Module for VEDA-IN MV SFT is identical for all ratings and suitable for mounting in L.V. Compartment**  
**Control Module Connection**

- Install the module in the L.V. compartment, which should be fully segregated from the H.V. compartment.
- Ensure that Control Module is properly grounded.
- Connect interposing relays to all VEDA-IN MV SFT auxiliary contacts, three relays must be incorporated: Run, Fault and By-pass.
- Fiber-optic technology is used to control the soft-starter, firing signals. Six fiber optic leads are connected to the firing boards on the Power Section and should be connected to the Fiber Optic connectors on the Control Module.
- Follow the fiber optic installation directions carefully and accurately at the end of the commissioning process.

### Fiberoptics Connections

1. Release fiber-optic nut CCW ½ a turn.
2. Remove 25mm fiber-optic lead from the insertion hole.
3. Identify the numbers for the F/O no the leads.
4. Insert Fiber-optic leads to their maximum (about 18mm).
5. Tighten fiber-optic nut gently, CW direction, ½ a turn.

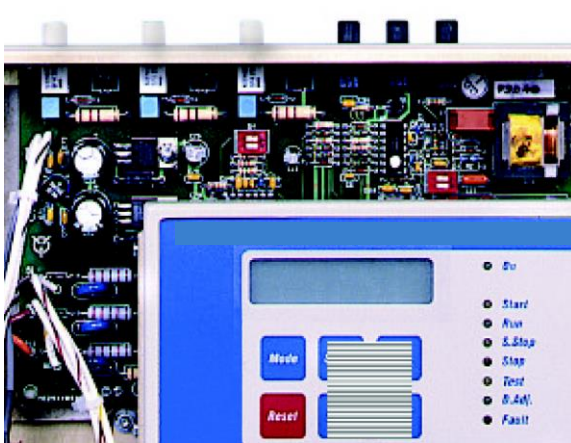

### Fiberoptics Board

Front view of the fiber-optic board. Fiber-Optic board dip - switches are located below f/o insertion connector # 5.



## Internal Settings

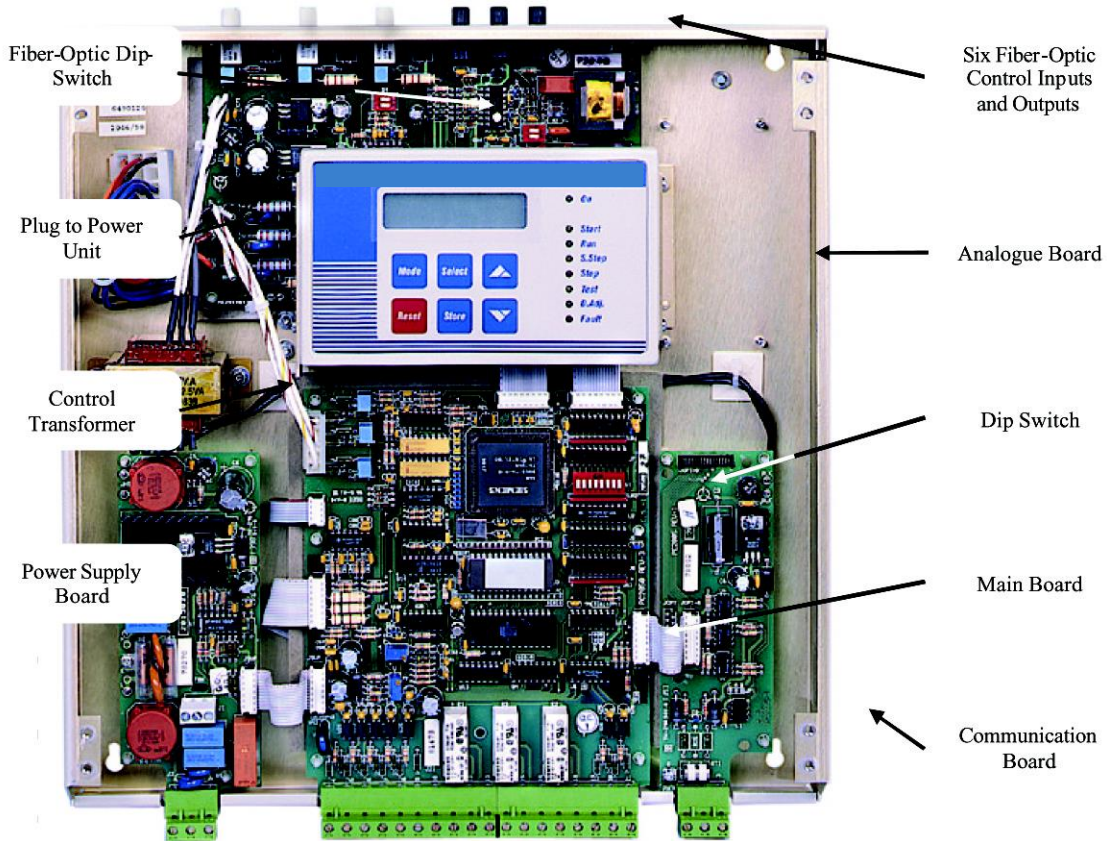

### Built-in memory systems

The VEDA-IN MV SFT incorporates 3 memory systems:

<b>EPROM</b>	A read-only, non-volatile memory, containing factory set parameters (default) that cannot be changed.
<b>EEPROM</b>	A read/write, non-volatile memory, where field adjusted parameters, statistical and fault data are saved and stored.
<b>RAM</b>	A read/write memory containing parameters loaded from the EEPROM which can be changed from the keypad. These parameters are stored only as long as Control Supply is connected.

### Memory system operation

1. When Control Supply is switched on, the RAM is automatically loaded from the EEPROM and parameters are displayed on the LCD.
2. Parameters can now be modified from the keypad (if starter is in one of the operating modes and software lock is open – Dip Switch 8 open).
3. Start parameters can be modified during starting process and will immediately affect the operation. Example: if Current Limit is set too low and motor does not accelerate to full speed, increasing the Current Limit setting will immediately affect the start process. This enables selection of the optimal starting characteristics.
4. After completion of the adjustments, parameters should be stored in the EEPROM. Storing of new parameters is possible at the end

## Internal Settings

---

of each Mode Page by pressing Store key after  
“Store Enable” is displayed on the LCD.

### **Test Modes:**

Two modes of test are available:

1. Test condition where the soft starter is tested for correct logical operation without Medium Voltage connected to it.
2. Test position where four pairs of dip - switches allowing a 400V motor test. The Motor is 1-5KW and Ground fault protection is overridden and G/F sensitivity is not required (when using a more accurate motor protection relay, etc.)



## Internal Settings

### Dip Switch settings (PC2050)

The Dip Switch module contains eight separate switches and located under the front cover of Control Module (size B-E) and under the Display unit (size A).

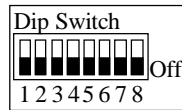

When necessary, carefully open the front panel and set the switches as required.

**Note:** All switches are factory pre-set in OFF position.

No	Switch Function	Switch Off	Switch On
1	Display Format	Minimized	Maximized
2	Tacho feedback	Disabled	Enabled
3	Main / Generator	Main	Generator
4	Must be Off		
5-6	LCD-language selection	See table	
7	Special settings – keep in Off position	Disabled	Enabled
8	Software lock	Open	Locked

### Switch # 1 – Display Modes

For operation convenience there are two display modes:  
Maximized – Display of all possible parameters.  
Minimized – Display of pre-selected parameters.

Setting Dip Switch # 1 to Off will minimize the LCD displays.

#### Maximized mode

Switch 1 – On

Display only  
Main parameters  
Start parameters  
Stop parameters  
Dual adjustment  
Slow speed parameters  
Fault parameters  
I/O programming  
Communication parameters

#### Minimized mode

Switch 1 – Off

Display only  
Main parameters  
Start parameters  
Stop parameters  
Statistical data

### Switch # 2 – Tacho feedback (Optional)

Set Dip Switch. # 2 to On, when using Incremental Shaft Encoder or tacho feedback.

**Note:** To operate tacho feedback—consult factory for specific settings for each application.

### Switch # 3 – Main / Generator control

When starting from a diesel – generator supply, starting process can sometimes terminate due to instability of the supply system. To operate generator mode set Dip Switch # 3 to On and special starting characteristics, suitable for Diesel Generator supply – with unstable voltage & frequency become operative. Closure of Dual Adjustment contact (terminal 8) operates the special starting characteristics.

When operating from network voltage and alternatively from diesel generator, set normal starting characteristics for Main and suitable parameters for the Diesel Generator (for example, faster acceleration, lower current limiting, etc.) on Dual Adjustment setting.



### Switches # 5, 6 – Language Selection



Language	Switch 5	Switch 6
English	Off	Off
French	Off	On
German	On	Off
Spanish	On	On

**Switch # 7 – Special settings** – consult factory



### Switch # 8 – Software Lock

The software lock prevents undesired parameter modification.

To lock, press Store and  or  keys and the LCD displays, “Unauthorized Access”.

## Control Terminals

**Control Supply ..... Terminals 1-3**  
110-120V or 220-240V, 50/60Hz as indicated on the front panel is required to power the electronic circuitry. This voltage can be supply from a grounded or ungrounded main system. It can be supply by special order for 110VDC.

**Note:** It is recommended that terminals 1-3 be always connected to the Control Supply.

**Spare..... Terminal 2**

### Control Inputs

Incorporating opto - couplers to isolate the micro - processor circuitry can be the same voltage as Control Supply above, 110-120 or 220-240V, 50/60Hz. By special order it can be supply for 24-110VDC.

**Note:** The VEDA-IN MV SFT is supplied as standard with the same voltage for Control Supply



**Stop..... Terminal 4**  
Input from a N.C contact. To stop the motor, disconnect control voltage from Terminal 4 for at least 250mSec.

**Soft stop..... Terminal 5**  
Input from a N.C contact. To soft stop the motor, disconnect control voltage from Terminal 5 for at least 250mSecs.

**Note:** If Soft-Stop is not required, connect a jumper between terminals 4 and 5.

**Start ..... Terminal 6**  
Input from a N.O contact. To start the motor, connect control voltage to Terminal 6 for at least 250mSecs.

### Notes:

1. Motor will start only if Stop (4) and Soft Stop (5) terminals are connected to control voltage.
2. Reset after a fault is not possible for as long as Start command is present.

**Input # 1 – Test / Reset..... Terminal 7**  
Input from a N.O contact. Selection between above functions is made from the keypad or through the communication.

One. Test 1 is designed for future enhancement. When connected through a N.O. contact, closing the contact operates Test 1.

Two. When Reset function is selected, connect terminal 7 to control voltage (use a N.O **momentary** contact) to reset the starter.

**Input # 2 – Dual Adjust / Reset..... Terminal 8**  
Input from a N.O contact. Selection between above functions is made from the keypad or through the communication (see I/O Programming).

One. Dual Adjustment function is selected by connects terminal 8 to control voltage to operate starter with the Dual Adjustment characteristic. Switching between Primary and Dual Adjustment settings can be done before and during starting. If a push-button arrangement is used, keep control voltage connected at least until RUN LED is lit.

**Note:** When starting from Diesel Generator or weak power supply set dip switch # 3 to on and connect terminal 8 to control voltage to operate starter with Generator Parameter settings.

Three. When “Reset” function is selected, connect Terminal 8 to control voltage (use a N.O momentary contact) to reset the starter.

**Common A ..... Terminal 9**  
Common for terminals 4, 5, 6, 7, 8.

**Note:** When control supply voltage and control input voltages are from the same source, connect a jumper between terminals 3 and 9.

## Control Terminals

---

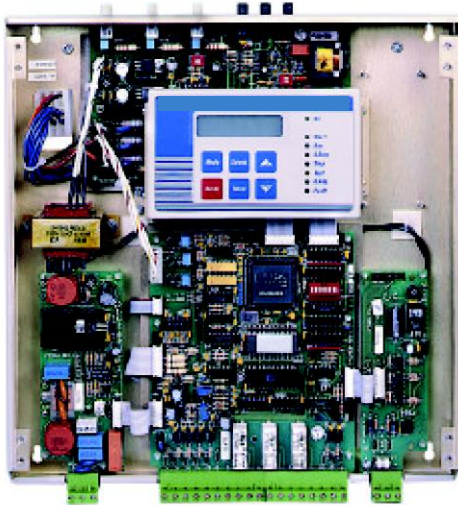

### **Immediate/Shear-pin Relay..... Terminals 10-11-12**

Terminals: 10-N.O. 11-N.C. 12 - Common.

Voltage free 8A, 250VAC max.

Selection between functions is made from the keypad or through the communication, (see I/O Programming), Programmable functions:

1. Immediate (after start signal)
2. O/C Shear-pin detection.

1. When Immediate is selected, the contact changes its position upon start signal. The contact returns to its original position upon Stop signal in case of a fault or control supply outage.  
When Soft Stop is operated, the contact returns to the original position at the end of the Soft Stop process.

The contact incorporates On & Off delays within 0 – 60 sec each.

The Immediate Contact can be used to:

- Interlocking with other systems.
  - Signaling.
  - Delay for opening an upstream contactor at the end of soft stop thus to allow current decrease to zero before opening the contactor.
  - Switch to / from Dual Adjustment settings with a time delay from Start signal (see Special Starting).
2. When O/C Shear-pin is selected, the contact changes position upon detection of Jam condition (Starter trip can be delayed within 0-5 sec.)  
The O/C Shear-Pin contact can be used to:
    - Interlocking with other systems.
    - Signaling
    - Delay for operating a reversing combination of contactors when Jam is detected to allow a clearing of a Jam condition.

### **Fault Contact ..... Terminals 13-14-15**

Terminals: 13-N.O. 14-N.C. 15 - Common

Voltage free 8A, 250VAC, 2000VA max. changes its position on fault. The contact is programmable to function as Trip or Trip fail safe relay.

One. When Trip function is selected- the relay is energized upon fault. The contact returns to its original position after fault has been removed and starter was reset or upon disconnection of Control Supply.

Two. When Trip-fail safe function is selected - the relay is energized immediately when Control Supply is connected and de-energizes upon fault or control Supply disconnection.

### **End of Acceleration Contact..... Terminals 16-17-18**

Terminals: 16 - N.O. 17 - N.C. 18 - Common

Voltage free 8A, 250VAC, 2000VA max. changes its position at the end of acceleration with an adjustable time delay (Contact Delay) of 0 – 120 sec.

The contact returns to its original position on Soft Stop or Stop signals on fault condition or voltage outage.

The End Of Acceleration contact must be used to close a by-pass contactor through a pilot (interposing) relay and can be used to:

- Activate a valve after compressor has reached full speed.
- Signal, allowing for the loading of a conveyor after motor reached full speed, etc.

### **Input # 3 (External Fault 1) ..... Terminal 19**

Input from a N.O contact connected between terminals 19 and 21. The starter will trip 2 seconds after contact closes.

# Control Terminals

**Input # 4 (External Fault 2) ..... Terminal 21**  
 Input from a N.O contact connected between termin als 20 and 21. The starter will trip 2 seconds after contact closes.

**Common B ..... Terminal 21**  
 Common for terminals 19, 20

**Note:**

**RS-485 Communication ..... Terminals 23-24**

Terminals: 23 (-), 24 (+)  
 Standard RS485, half duplex with MODBUS protocol, bound rate 1200, 2400, 4800, 9600 BPS. Twisted shielded pair should be used and shield connects to ground on the PLC/Computer side. Terminals 4 & 5 must be wired to control supply voltage for operation in communication mode (see Communication Wiring Diagrams).

**Analog I/O (option # 5) ..... Terminals 28-32**

Terminals 28-29 leave open  
 Terminals 30 connect to ground (shield)  
 Terminal 31 – Analog output (-)  
 Terminal 32 – Analog output (+)

The Analog card output incorporate two functions (Voltage & Current outputs).

Dip switches allow selection between:  
 0-10VDC, 0-20 mA and 4-20 mA

The Analog value is related to the motor current and can be programmed to normal or inverted output. (Default = Normal)  
 Maximum value (20mA or 10Vdc) is related to 2 x In.

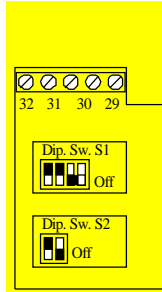

1. When Control Supply voltage and Control Input voltage are from the same source, connect a jumper between terminals 3, 9 and 20.
2. If External inputs 1 & 2 are not used, leave termina 21 open.

Dip switch No.	4-20 mA*	0-20 mA	0-10VDC
Dip-Switch S1#1	On	On	Off
Dip-Switch S1#2	On	On	Off
Dip-Switch S1#3	Off	Off	On
Dip-Switch S1#4	Off	Off	On
Dip-Switch S2#1	On	Off	Off
Dip-Switch S2#2	No use	No use	No use

\* Default

# Control Wiring

1	} ~ Control Supply
2	
3	
4	Stop
5	Soft Stop
6	Start
7	Input # 1
8	Input # 2
9	Common A (of 4..8)
10	} Immediate Relay
11	
12	
13	} Fault Relay
14	
15	
16	} End Of Acceleration Relay
17	
18	
19	Input # 3
20	Input # 4
21	Common B (of 19..20)
22	Leave Open
23	(-) RS 485
24	(+) RS 485
30	Leave Open
31	(-) Analogue Output
32	(+) Analogue Output

Control Supply must be protected by a 1A fuse.  
It is recommended to use a separate fuse for the auxiliary circuits.

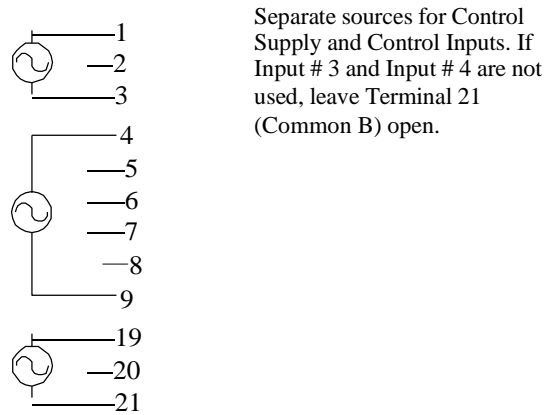
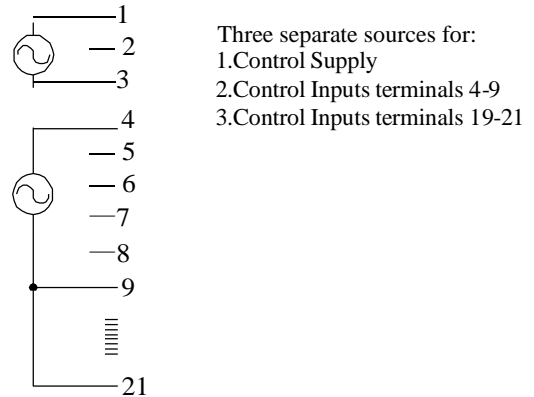
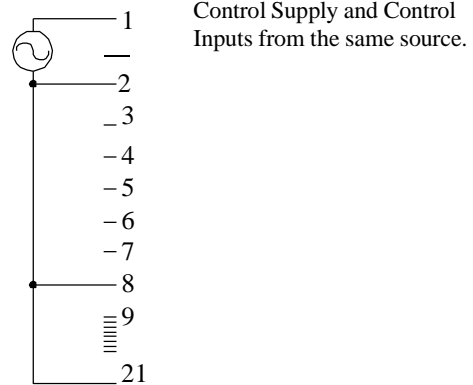

## Notes:

- Standard control and input voltage are 115 or 230VAC.  
DC Supply sources available by special order.  
See ordering information and consult our factory.
- If External faults are not used leave terminals 19, 20, 21 open.

# Control Wiring

1. Start, soft stop and stop buttons, single supply source for Control Supply and Control Inputs. If Soft Stop is not used, connect a jumper between terminals 4-5 and connect emergency stop and/or soft stop between terminals 1-4.

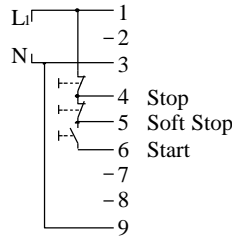

2. Start-Stop push buttons. Separate sources for Control Supply and Control Inputs. If Soft Stop is not used, connect a jumper between terminals 4-5.

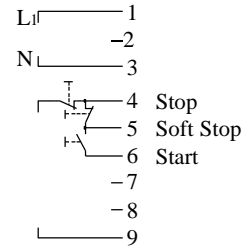

2. Motor will soft start when C closes and stop immediately when C opens.

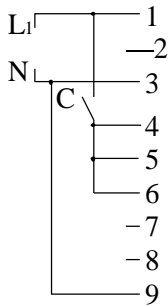

3. Motor will soft start and soft stop with C. C<sub>1</sub> acts as emergency stop.

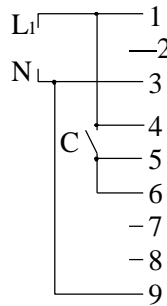

4. Motor will soft start and soft stop with C. C<sub>1</sub> acts as emergency stop.

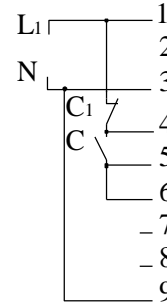

5. Close C to operate Test, Slow speed or Reset – as selected.

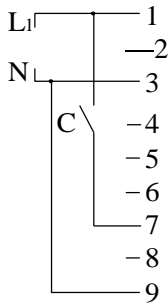

- C must be of momentary type when used as Reset.

6. Close C to operate Dual Adjust, Reversing or Reset – as selected.

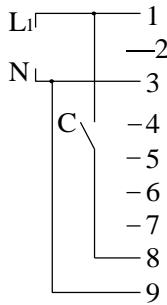

- C must be of a momentary type when used as Reset.

7. External Fault contacts. The starter will trip 2 seconds after C or C<sub>1</sub> would close.

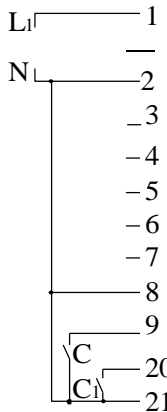

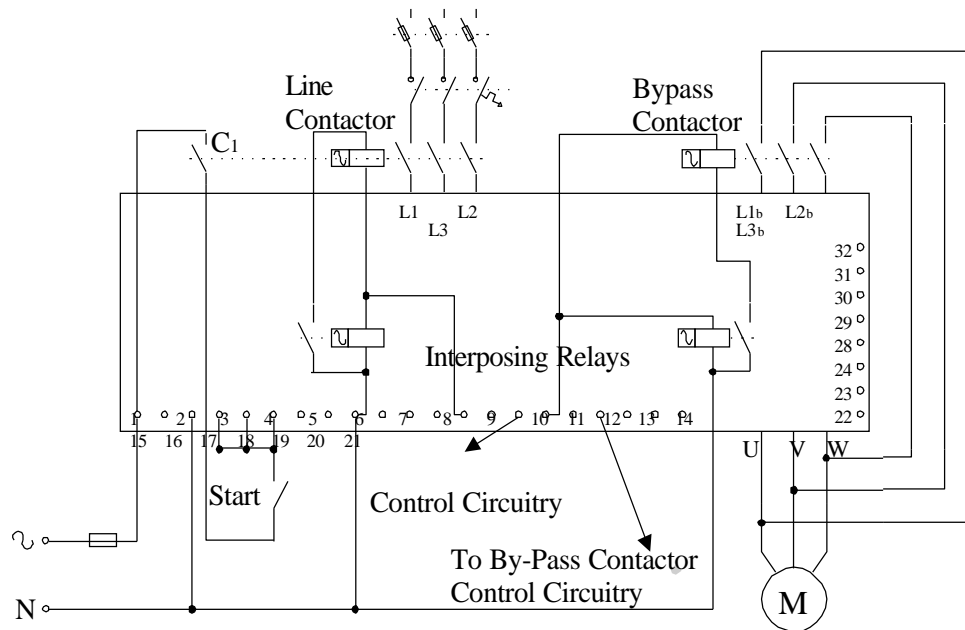

### Series contactor

- A Line contactor and by-pass contactor must be used
- To incorporate soft stop, use Run contact off delay to “Hold” the Line Contactor.

This system is used mainly when the VEDA-IN MV SFT is retrofitted into an existing system, thus, reducing modifications in existing installations. Main power and Start signal are switched on upon closure of the series contactor. The starter will operate as long as the series contactor is closed.

#### Notes:

1. It is recommended that terminals 1-3 shall be always connected to Control Supply.
  2. Upstream contactor must be opened immediately after soft stopping. The upstream contactor can be interlocked via the Immediate Contact that changes its position only at the end of soft stop. It is therefore recommended to delay the opening of the upstream contactor for a few seconds after the completion of soft stop process (after current reached zero). See Immediate / Shear-p in contacts delay – page 6.
- Ensure that auxiliary contact  $C_1$  closes together with or after the main contactor. The soft-starter provides a 500 mili seconds delay for the start signal. If it close before, Under Voltage fault will occur.

### By-pass contactor

End of Acceleration contact is activated after an adjustable time delays “Run Contact Delay” – see page 23 at the end of start-up period, closing the by-pass contactor.

- By-Pass Open failure will trip the starter if a By-pass contactor is not used.

The contact will return to its original position when:

- Soft Stop or Stop signals are initiated.
- Slow-Speed signal is initiated.
- Fault conditions occur.

When the by-pass contactor closes, current to the motor will flow through the by-pass. When a Soft Stop signal is given, the End of Acceleration contacts return to its original position opening the by-pass contactor. Thereafter, the voltage will gradually ramp down to zero to soft stop the motor.

## Wiring Diagrams – Diesel Generator

Starting from Diesel-Generator or very weak main.

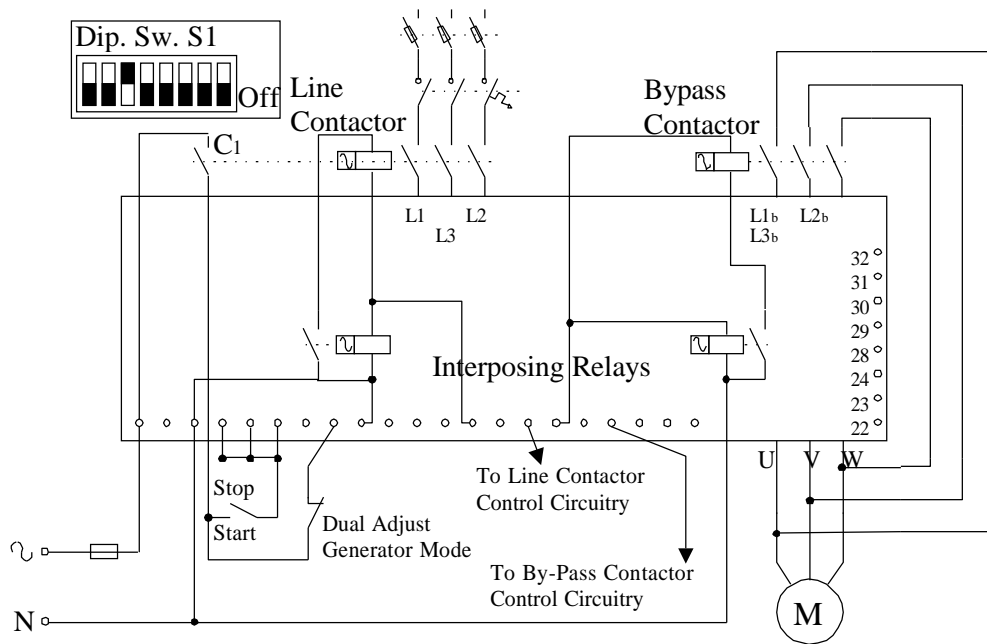

ALWAYS TRY STANDARD STARTING FIRST!

IF STANDARD DID NOT OPERATE, USE GENERATOR MODE.

- When starting from a Diesel – Generator the voltage regulator (especially older type regulators) may be affected during the starting process and cause a rapid voltage fluctuations. In these rare cases, the voltage regulator must be upgraded – consult your Diesel-Generator Supplier.
- In most cases where voltage, current or frequency is unstable– a special routine may be applied to overcome the starting difficulty. Use the procedure below:
  - Set Dip Switch # 3 to “On” (as shown above).
  - Insert a contact (or jumper) between Control Supply and terminal 8 (Dual Adjustment Terminal) and close contact to operate the Generator Mode. Dual Adjust. LED will light when operating in Generator Mode.
  - Set Dual Adjust parameters to the values necessary for the application (e.g. faster acceleration, lower current limit, etc.).
- When operating from network voltage and alternatively from Diesel Generator set the normal starting characteristics for main voltage and suitable parameters for the Diesel Generator on Dual Adjustment setting. When starting from main, the primary settings suitable for main starting will operate. Upon starting from Generator close contact between Control Supply and terminal 8 to operate Generator Mode.

**Note:** Ensure that Diesel Generator size is suitable (Diesel Generator KVA is approximately at 1.35 motor KVA).

### WARNING

- Motor can not run idle and must be loaded when operating in Generator Mode, otherwise vibration may occur during starting and stopping.
- When using extended range, use maximum precaution to avoid motor or starter burnout.
- Disconnect all other loads before starting for the first time to prevent damages due to voltage fluctuations.
- Disconnect Power Factor capacitors when operating with Diesel Generator



## Wiring Diagrams - Communication

### Operation via communication link with Local / Remote selector switch

- **Remote: via Communication Link**
- **Local: Soft-start, soft-stop by maintained contact.**

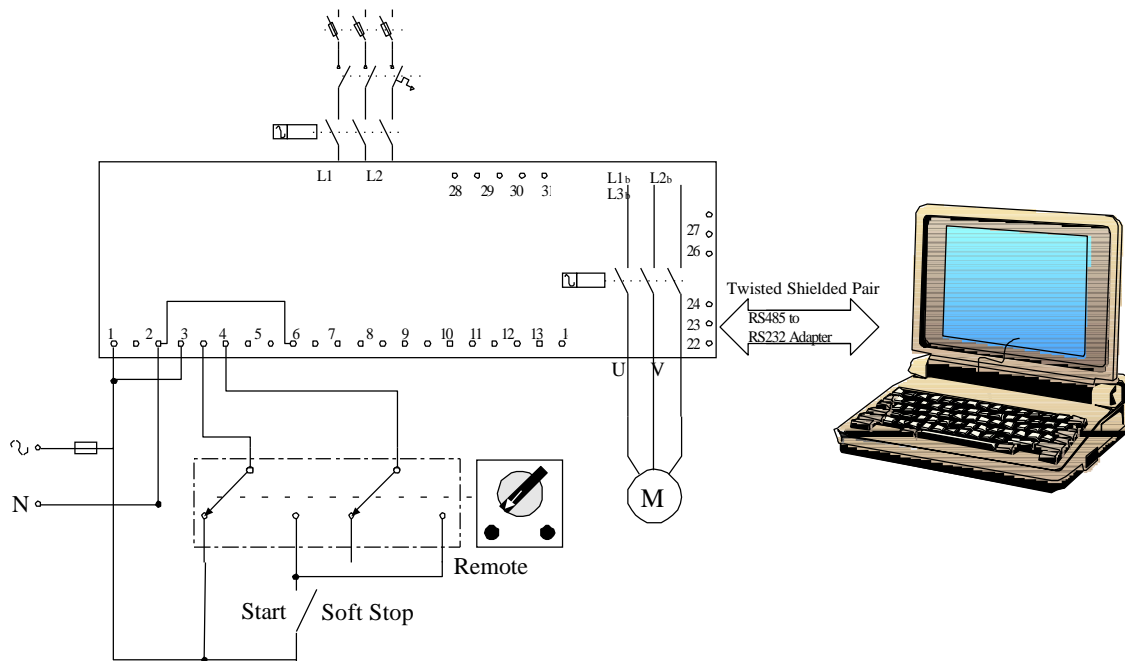

The communication enables remote parameter settings and readings. For start, stop, soft-stop, dual adjust, etc. terminals 4 and 5 must be wired as shown.

### Soft-start and soft-stop

- Program the “Serial Link Number” in the communication page to a number between 1 -247.
- Disconnect control supply, so the new information will be loaded on the next time you turn it on.
- Connect a communication line (twisted shield pair) with its (+) to terminal 24 and (-) to terminal 23, connect the other end to your host computer containing RS-485 communication port with MODBUS protocol.
- Connect other terminals as follows:
  1. Terminal 1, 3 and Control Supply
  2. Terminal 4 to Control Supply phase
  3. Terminal 9 to Common for terminals 4, 5, 6.
  4. During operation via communication link, terminal 5 is connected through the “Local-Remote” selector switch to Control Supply and start-stop commands are controlled through the communication port. During operation in Local mode, terminals 5 and 6 are connected to Control Supply through the start/soft-stop toggle switch.

### WARNING

Starter and host computer must be grounded when communicating with VEDA-IN MV SFT



## Wiring Diagrams - Communication

Operation via communication link with Local / Remote (Selector switch)

- Remote via Communication link
- Local to soft-start or immediate stop by maintained contact.

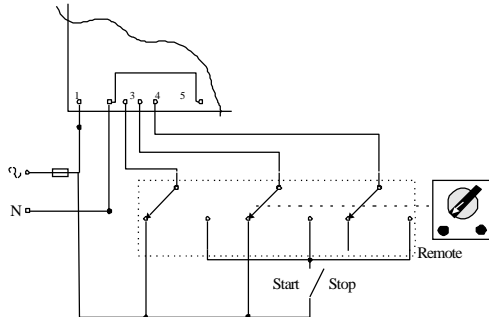

### Soft-start and Immediate stop

Same as the explanation for soft-start and soft-stop except # 4:

4. During operation via communication link, terminals 4 and 5 are connected through the Local / Remote selector switch to Control Supply and start-stop commands are controlled through the communication port. During operation in Local mode, terminals 4, 5 and 6 are connected to Control Supply through the start-stop toggle switch.

Operation via communication link with momentary contact Push-Buttons to Soft-start, immediate stop and soft-stop

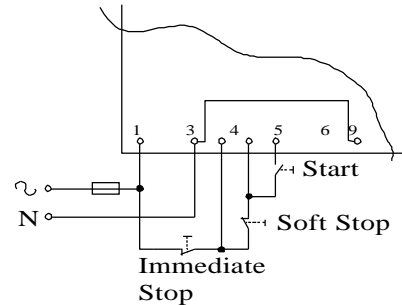

### Soft-start, soft-stop and Immediate stop

Same as the explanation for Soft-start and soft-stop except # 2 and # 4:

2. Connect terminal 4 as described above.
4. During operation via communication link, terminals 4 and 5 are connected through the push-buttons to Control Supply and start / stop commands are controlled through the communication port. During normal operation mode, terminals 4, 5 are connected to Control Supply through the immediate stop and soft stop push buttons. Soft start command may be initiated by pressing the start push button.

**Notes:** The communication (data retrieval and statistics) is active at all time!

If control signals (start, stop, etc.) are required, terminals 4 and 5 have to be wired in accordance with the appropriate wiring diagram:

1. Maintained soft start and stop.
2. Maintained soft start with immediate stop.
3. Soft start / stop with immediate stop via push-button control.

# Start & Stop Parameters

## Pump Control – Start Curves

Induction motors produce peak torque of up to 3 times the rated torque towards the end of starting process. In some pump applications, this peak may cause high pressure in the pipes.

The VEDA-IN MV SFT incorporates 4 different starting curves:

**Start Curve 0** – Standard curve (Default). The most stable and suitable curve for the motor that prevents

**Start Curves 1, 2, 3** – During acceleration, before reaching peak torque, the pump control program automatically controls the voltage ramp-up to reduce peak torque.

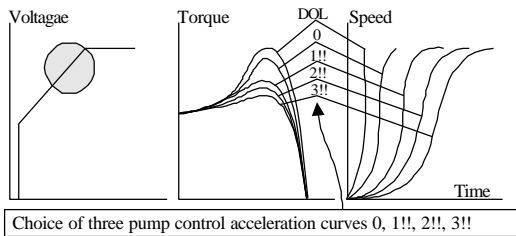

**Note:** Always starts with Start Curve 0. If towards the end of acceleration, the peak torque is too high (pressure is too high), proceed to Curve 1 then 2 or 3 if necessary.

## Tacho Feedback, Incremental Shaft Encoder (Optional)

Provides linear acceleration and deceleration curves according to rpm feedback. 12 tacho gain levels can be selected for closed loop control starting and stopping.

**Note:** Consult factory for additional information.

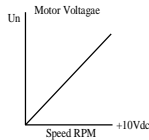

## Pulse Start

Intended to start high friction loads, requiring high starting torque for a short time.

A pulse of approximately 80%  $U_n$ , without current limit is initiated to break the load free. Pulse duration is adjustable within 0.1– 1 sec.

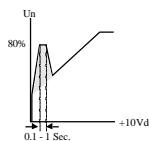

After this pulse the voltage is ramped down to initial voltage setting before ramping up again to full voltage according to start parameters settings.

## Initial Voltage

Determines the motor initial starting torque (the torque is directly proportional to the square of the voltage). Range: 10-50%  $U_n$  (consult factory for extended range). This adjustment also determines the inrush current and mechanical shock. A setting, which is too high, may cause high initial mechanical shock and high inrush current (even if current limit is set low as the Initial Voltage setting overrides Current Limit setting).

A setting that is too low may result in prolonged time until motor begins to turn. In general, this setting should ensure that the motor begins turning immediately after start signal.

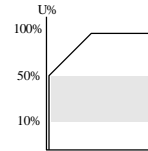

## Current limit

Determines the motor highest current during starting. Range 100-400% of FLA setting (consult factory for extended range). A too high setting will cause greater current drawn from main voltage and faster acceleration.

A setting that is too low may prevent motor from completing acceleration process and reaching full speed. In general, this setting should be set to a high enough value in order to prevent stalling.

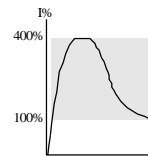

**Note:** Current limit is not operating during Run and soft stop.

## Acceleration Time

Determines the motor voltage ramp-up time from initial to full voltage. Range 1-30sec. (consult factory for extended range). It is recommended to set acceleration time to the minimum acceptable value (approx. 5 sec).

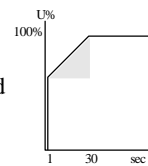

## Notes:

1. Since current limit overrides acceleration time when current limit is set low, starting time will be longer than the preset acceleration time.
2. When motor reach full speed before voltage reach nominal voltage, acceleration time setting is overridden and cause the voltage to ramp-up quickly to nominal.
3. Starting curves 1, 2, 3 prevents quick ramp up.

# Start & Stop Parameters

## Maximum Start Time

The maximum allowable starts time from start signal to the end of acceleration. If voltage does not reach full voltage during this time (for example, because of low current limit setting), the starter will trip the motor. LCD displays “Long Start Time” message.  
Range: 1-30 sec (consult factory for extended range).

## Contact Delay

Time delay for the End of Acceleration contact after completion of starting process. Range: 0-120 sec.

## Pump Control – Stop curve

Intended to prevent water hammer during stopping. In pump applications, load torque decreases in square relation to the speed and reducing the voltage will reduce torque so motor will smoothly decelerate to stop.

The following **Stop curves** can be selected:

**Stop curves 0** – Standard Default curve – voltage is linearly reduced from nominal to zero.

**Stop curves 1, 2, 3** – In some pump applications, when pumping to a high level, a considerable part of the torque is constant and does not decrease with speed. It may happen that during soft stop, when voltage decrease, motor torque quickly falls below load torque and motor will abruptly stall instead of smoothly decreasing speed to zero.

Curves 1, 2, 3 designed to prevent stall condition

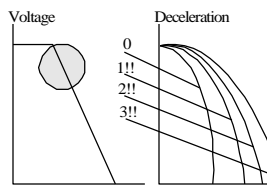

**Note:** Always use stop curve 0. If motor stalls quickly instead of slowly decreasing its speed, select stop curve 1, then 2 or 3 if necessary.

## Deceleration Time– Soft Stop

Used for controlled deceleration of high friction loads. Determines motor voltage ramp down time.  
Range: 1-30 sec. (consult factory for extended range).

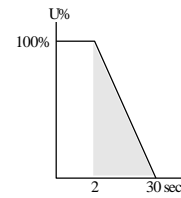

**Note:** soft stop initiation opens the End Of Acceleration contact and opens the by-pass contactor. Load will be transferred to the VEDA-in MV SFT and voltage begins to ramp down.

## Final Torque

Determines torque towards the end of soft stop. If current is still flowing after speed is softly reduced to zero, increase the final torque setting.

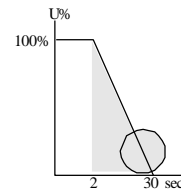

## Dual Adjustment

A secondary set of parameters used for varying loads, two speed motors, etc. Connecting control supply to Terminal 8 makes transfer to Dual Adjustment settings.

- Initial Voltage 10-50% of  $U_n$ .
- Current Limit 100-400% of motor's FLA.
- Acceleration Time 1-30 sec.
- Deceleration Time 1-30 sec.
- Motor Full Load Ampere.

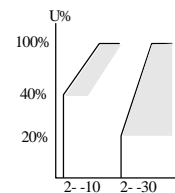

**Note:** Consult factory for extended range.

# Motor & Starter Protection

## Too Many Starts

Combines three parameters:

- **Number of Starts**  
Determines the maximum allowable number of starts.  
Range: Off, 1-10 starts. Default: 1
- **Start Period**  
Time period when number of starts is being counted. Range: 1-60 min. Default: 20 Min.
- **Start inhibit**  
Determines time period when start signal is disabled after “Too many starts” trip.  
Range: 1-60 min

**Note:** Motor can not be started before “Start Inhibit Time” has elapsed. Trying to start the motor during this time delay will result in LCD displaying “Wait Before Restart: \_\_\_ MIN.

## Long Start Time – (Stall Protection)

Trips the starter if motor does not reach full speed during “Maximum Start Time”.  
Range: 1-30 sec. (consult factory for extended range).

## Over Current Shear-pin trip

Operational when starter is energized and has two functions:

- Trips the starter when current exceeds 850% of starter’s FLC setting in 1 cycle or less.
- During run (after RUN LED is on) it trips the starter if current exceeds set level and time delay. Range: 200- 850% of motor FLA setting  
Delay: 0 – 5 sec. (0=up to 200 msec)

**Note:** The O/C Shear-Pin trip is not intended to replace the fast acting fused. It is required to protect the thyristors (see fuse table in the appendix).

## Overload (OL)

Inverse time electronic overload becomes operational when RUN LED is on.

The OL circuitry incorporates a Thermal Memory Register, which calculate the heat less the dissipation of the motor. The starter trips when the register fills up. The thermal register resets itself 15 minutes after the motor stops.

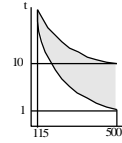

The value is adjustable within 75-150% of motor FLA and factory pre-set at 115%.  
Tripping time at 500% FLA is adjustable within 1-10 seconds to allow trip curve selection.

**ATTENTION**  
Overload protection is not operative during soft-start or soft-stop.

## Under Current

Operational when motor is running. Trips the starter when motor current drops below under current trip (UCT) set point for a period of time longer than under current delay (UCD).

Under Current Trip range: 0 = Off, 20-90% of FLA  
Under Current Delay range: 1-40 sec.

## Auto Reset

A special feature enables auto reset after adjustable time delay. Range: Off, 10-120 min.

## Under Voltage / No Voltage

Operational after start signal. It trips the starter when main voltage drops below the Under Voltage Trip set point for a period of time longer than Under Voltage Delay.

Auto reset can be activated via Fault Parameters. Auto reset is activated 60 seconds after trip occurred.

Under Voltage Trip range: 70-90% Un (Line to Line)  
Under Voltage delay range: 1-10 sec.

## Note:

1. When voltage drops to zero (voltage outage) the starter will trip immediately, overriding the delay.
2. Auto reset can not be activated if start signal is still connected.

## Motor & Starter Protection

---

### Over Voltage

Operational after start signal. It trips the starter when main voltage exceeds the Over Voltage Trip set point for an adjustable period of time longer than Over Voltage Delay.

Range: 110 – 125% of Un (Line to Line)

Over Voltage Delay range: 1-10 sec.

### Phase loss (with programmable auto reset)

Operational when starter is energized and protects motor from loss of phase. It trips the starter when one or two phases are missing. Auto reset can be activated via Fault Parameters. Auto reset is activated 60 seconds after trip occurred.

#### Note:

1. Phase loss might not be detected in lightly loaded motors.
2. Auto reset can not be activated if start signal is still connected.

### Phase Sequence

IT trips the starter when starter is energized and phase sequence is wrong.

### Long Slow-Speed Time (for future enhancement)

### Wrong Connections & Shorted SCR

Operational after start signal. It trips the starter if motor is not properly connected to starter's Load terminals, when:

- Internal disconnection in the motor winding is detected.
- In case one or more SCRs have been shorted.
- Incorrect fiber-optic lead insertion.

### Heat-sink Over Temperature

Thermal sensors are mounted on the heat-sink and trip the starter when temperature rises above 85°C.

### External Fault 1 & 2

Operational when starter is energized. It trips the starter when an external contact closes for more than 2 sec.

### Unbalance Current Trip

Operational after start signal. It trips the starter when current unbalance increases above the preset "UNBALANCE TRIP" for more than the "UNBALANCE DLY" set-point.

Range: 10-100%. Delay: 1-60 sec.

### Ground Fault Trip

Operational after start signal. It trips the starter when ground current increases above the preset "GND Fault TRIP" for more than "GND FAULT DLY" set point. Range: 10-100%. Delay: 1-60sec.

### Power ON & No Start

Operational upon main voltage connection. It trips the motor when main voltage is connected to the VEDA-IN MVSFT for more than 30 sec. without a start signal.

### By-pass Open

Operational when the by-pass contactor did not close after End Of Acceleration contact signaled the pilot (interposing) relay to close.

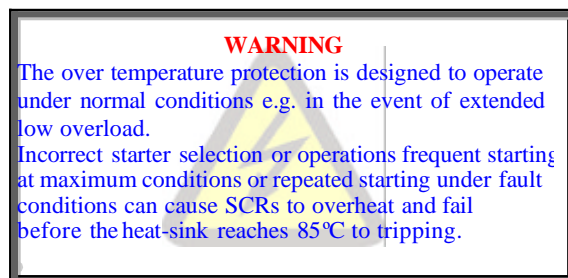

### Fault and Reset

When any of the above protection operates, the starter locks in a fault condition and disables thyristors firing. Fault LED lights on, fault description is displayed on the LCD and Fault Relay operates.

- For local resetting, after fault has been removed, press Reset Key.
- Remote resetting can be done through terminals 7 or 8 (see I/O Programming – page 26).

When Fault occurs followed by a voltage outage, fault condition is latched and reappears upon voltage restoration.

**Note:** Resetting is not possible when Start signal exists.

### Auto Reset Under –voltage & Phase-loss

Under-voltage & Phase-loss faults can be set to Auto-Reset (see Fault Parameters – page 25). The starter will reset itself 60 seconds after the trip, provided that no start signal exists.

### Auto Reset Under-current

Under-current fault can be set to Auto-reset (see Fault Parameters – page 25). The starter will reset itself after the adjustable "UNDER CUR. RESET" provided that no start signal exists.

## Motor And Starter Protection Occurrence Table

Timing And Occurrence	Active During			
	Start	Run	Stop	Soft Stop
<b>Too many starts</b>	✓			
<b>Electronic Overload</b>		✓		
<b>Shear Pin (Jam) *</b> Default setting				
Starter Protection – trip function at 850% FLC	✓	✓		✓
<b>Motor Protection – trip function</b>				
During Start – factory set at 850% FLA in less than 1 cycle.	✓			✓
During Run – adjustment 200 – 850% FLA within 1 cycle		✓		
<b>Programmable setting (Dip switch # 2 On)</b>				
Starter Protection – trip function at 850% FLC	✓	✓		✓
<b>Motor Protection – Alarm &amp; Trip functions</b> On fault “Immediate Relay” acts as alarm w/adjustable delay. Trip will not occur if fault is cleared within the time delay.				
During Start – preset at 850% FLA, adjust. Delay (Imm. Relay)	✓			✓
During Run – adjust. 200-850% FLA adjust. Delay (Imm. Relay)		✓		
<b>Under current</b>		✓		
<b>Unbalance Current</b>	✓	✓		✓
<b>Ground Fault Current</b>	✓	✓		✓
<b>Phase loss</b>	✓	✓		✓
<b>Phase sequence</b>	✓	✓		✓
<b>Under voltage</b> . Time delay is override in case of “No -Volt”.	✓	✓		✓
<b>Over voltage</b> with adjustable time delay	✓	✓		✓
<b>Long start time</b> (Stall protection)	✓			
<b>Shorted SCR &amp; Wrong connection</b> (Load Loss)	✓			✓
<b>External fault 1 &amp; 2</b>	✓	✓	✓	✓
<b>SCR protection</b> by Metal Oxide Varistors (MOV)	✓	✓	✓	✓
<b>Starter over-temperature</b>	✓	✓	✓	✓
<b>Starter internal test</b> When supply voltage is connected and LED is “On” .	✓	✓	✓	✓
<b>PWR ON &amp; NO STRT</b>			✓	
<b>By-Pass Open</b>		✓		

## **Motor and Starter protection Occurrence Table**

---

**Leave blank for future update**



## Front Panel



### LED Arrangement

#### On

Lights on when Control Supply voltage is connected to the starter.

#### Start

Lights on during start process, indicating that motor supply voltage is ramping up.

#### Run

Lights on after completion of starting process to indicate that motor is receiving full voltage. It flashes during slow speed operation.

#### S. Stop

Lights on during soft stop process to indicate that motor supply voltage is ramping down.

#### Stop

Lights on when motor is stopped.

#### Test

Lights on when in “Test Mode” operation.

#### D. Adj.

Lights on when Dual Adjustment is in operation.

#### Fault

Lights on upon operation of any of the built-in protection.

### Keypad

Provides selection of the following modes:

When Dip Switch 1 is in “On”, gray zone shows list of maximized parameters).

- Display Only
- Main Parameters
- Start Parameters
- Stop Parameters
- Statistical Data
- Dual-Adjustment Parameters
- Slow Speed Parameters
- Fault Parameters
- I/O Programming Parameters
- Communication Parameters.

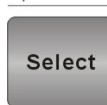

To select function within each mode.

To increase adjusted parameters. Press momentarily or continuously.

To decrease adjusted parameters. Press momentarily or continuously.

To save modified parameters.

To reset the starter after fault has been removed, canceling the displayed fault and allows restarting. Disconnect Start signal to Enable reset.

**Note:** Pressing **Mode** or **Select** continuously increases parameters changing speed.

# Display Mode



## LCD Arrangement

Two lines of 16 characters display: System Parameters, Starter Settings, Motor Current, Insulation and Fault Identification. Four selectable languages – English, French, German and Spanish (see Dip Switch setting–page 15).

**CURRENT LIMIT**  
390%

- Upper line displays functions.
- Lower line displays setting and measured values.

### Modifying parameters

1. Press **Mode** key several times until you reach the required **Mode** page.
2. Press **Select** to review parameters of this mode.
3. When reaching the required parameter, modify its values with  or  keys.
4. To store the new parameters, press **Select** until “Store Enable” appears and then press **Store** key

**Note:** Pressing **Mode** or **Select** keys continuously increase parameter change speed.

### Mode pages

Upon Control Supply connection, the LCD displays motor’s operating current. When Dip Switch # 1 is set to On (see Display Options–page 21) All Mode Pages can be reviewed by pressing the **Mode** key. When Dip Switch # 1 is set to off, the following Mode pages marked \*\* will not appear.

**START PARAMETERS**

**STOP PARAMETERS**

**DUAL ADJUSTMENT  
PARAMETERS**

**FAULT PARAMETERS**

**I/O PROGRAMMING  
PARAMETERS**

**COMM. DATA**

**STATISTICAL DATA**

In this mode, parameters are not adjustable.

**% OF MOTOR FLA**

Displays operating current as a percentage of motor’s FLA.

**Note:** Starter’s Default Display. A time delay is initiated after pressing **Mode** or **Select**. Following the delay, the LCD defaults back to display “% OF MOTOR FLA”. Five minutes after programming the LCD it returns to the Current Display.

**Press** **Select** – When Analog card is incorporated.

When option cards are not incorporated, the LCD displays

**OPTION CARD**  
Not Installed

When incorporated, the LCD displays

**ANALOG OUTPUT**  
NORMAL

Displays analog card preset.

### This concluded the “Display Mode”

Pressing **Select** key at this point returns to the first display.

### Obtaining “Default Parameters”

One. Press **Mode** and  keys simultaneously and the LCD will display “Store Enable Default Parameters.”

Two. Press **Store** and **Mode** keys simultaneously.

**CAUTION**  
Obtaining Default Parameters will erase all previously modified settings.

VEDA-IN MV SFT FLC must be set to the rated starter current as specified on the starter label.

## Parameter Settings

Press **Mode**

To advance to:

**MAIN & PROTECT.  
PARAMETERS**

Press **Select**

Press   keys to set starter FLC. Range: 20 - 1000

**STARTER FLC  
150 AMP**

Press **Select**

Press   keys to set motor FLA. Range: 50-100% of "STARTER FLC"



**MOTOR FLA  
150 AMP**

Press **Select**

Press   keys to Under Current Trip set point. Range: 0 = OFF, 20-90% of FLA



**UNDERCURREN. TRIP  
0% OF FLA**

Press **Select**

Press   keys to under Current Trip time delay set point. Range: 1-40 sec.

**UNDERCURREN. DELAY  
10 SEC.**

Press **Select**

Press   keys to Over Current Shear-pin set point. Range: 200 - 850% of FLA



**O/C - SHEAR PIN  
850% OF FLA**

Press **Select**

Press   keys to set O/C Shear-pin time delay. Range: 0.5-5 sec.



**O/C DELAY  
1.5 SEC.**

Press **Select**

Press   keys to set Overload Current Trip. Range: 75-150% of FLA



**OVERLOAD TRIP  
115% OF FLA**

Press **Select**

Press   keys to set Overload Trip time delay at 500% of motor FLA. Range: 1-10 sec.



**OVERLOAD DELAY  
4 SEC - AT 5 FLA**

Press **Select**

Press   keys to set Unbalance Trip. Range: 10-100% of motor FLA



**UNBALANCE TRIP  
20%**

Press **Select**

Press   keys to set Unbalance Trip time delay. Range: 1-10 sec.



**5 SEC.**

Press **Select**

Press   keys to set Ground Fault Trip. Range: 10-100%

**GND FAULT TRIP  
20% OF FLA**

Press **Select**

Press   keys to set Ground Fault Trip Delay. Range: 1-60 sec.

**GND FAULT DELAY  
5 SEC.**

Press **Select**

Press   keys to set Under Voltage Trip. Range: 70-90% of Un.



**UNDERVOLT. TRIP  
75% of Un**

Press **Select**

Press   keys to set Under Voltage Trip time delay. Range: 1-10 sec.



**UNDERVOLT. DELAY  
5 SEC.**

Press **Select**

Press   keys to set Over Voltage Trip. Range: 110-125% of Un (can not be set below Under Voltage)

**OVERVOLT. TRIP  
120% of Un**

Press **Select**

Press   keys to set Over Voltage Trip time delay. Range: 1-10 sec.

**OVERVOLT DELAY  
2 SEC.**

**STORE ENABLE  
MAIN PARAMETERS**

Press **Store** Key to store selected parameters.

**Note:** Storing selected parameters is possible only when stop or run LED are on. Storing cannot be done when start, soft stop or fault LED is on.

When parameters have been correctly stored the LCD displays

**DATA SAVED OK**

**This concludes Main & Protection Parameter settings.**

Pressing **Select** key after "Data Saved OK" returns to the first display in this mode.

In case of a failure in parameter storing the LCD displays.

**STORAGE ERROR**

Press **Select** button again until "Store Enable Main Parameters" returns then press **Store** key until "Data Saved OK" appears.

## Parameter Settings

Press **Mode**

To Advance to:

**START PARAMETERS**

Press **Select**

**SOFT START CURVE**  
1 (STANDARD)

Then press   keys to set Soft Start Curve:

- 0 = Standard Curve
- 1!! = Pump Control Curve # 1
- 2!! = Pump Control Curve # 2
- 3!! = Pump Control Curve # 3

When setting dip switch # 2 to on for Tacho Mode

Press **Select**,   curve message changes to:



**START TACHO. GAIN**  
0 (MIN. GAIN)

Then press   keys to set Tacho gain:

- 0 = Minimum gain tacho control.
- 1!! = Second level Tacho gain.
- 2!! = Third level Tacho gain.
- 3!! = Fourth level Tacho gain.
- 4!! = Fifth level Tacho gain.
- 5!! = Sixth level Tacho gain.

**Note:** Tacho feedback is operational in its basic form. Additional curves except for the basic linear curve are optional. Consult factory for correct tacho selection and mechanical installation.

Press **Select**

Press   keys to set Pulse Start Time. Range: 0-2 sec. (Pulse level at 80% Un)



**PULSE TIME**  
0 SEC.

Press **Select**

Press   keys to set Initial Voltage. Range: 10-50% of Un.



**INITIAL VOLTAGE**  
30%

Press **Select**

Press   keys to set Current Limit  
Range: 100-400% of motor FLA.

**CURRENT LIMIT**  
400% OF FLA

Press **Select**

Press   keys to set Acceleration Time  
Range: 1-30 sec.



**ACC. TIME**  
10 SEC.

Press **Select**

Press   keys to maximum Start Time. Range: 1-30 sec.



**MAX. START TIME**  
30 SEC.

Press **Select**

Press   keys to set the number of starts permitted (during START period below)  
Range: 1-10, Off.



**NUMBER OF STARTS**  
1

Press **Select**

Press   keys to set number of starts time period. Range: 1-60 min.



**STARTS PERIOD**  
30 MIN.

Press **Select**

Press   keys to set start inhibit period  
Range: 1-60 min.

**START INHIBIT**  
15 MIN.

Press **Select**

Press   keys to set time delay for the end of acceleration contact.  
Range: 1-120 sec.

**RUN CONTACT DEL.**  
5 SEC.

Press **Select**

To store selected parameters, press **Store** key.

**STORE ENABLE**  
**START PARAMETERS**

When parameters have been correctly stored the LCD reads:

**DATA SAVED OK.**

## Parameter Settings

Press **Mode**

To advance to

**STOP PARAMATERS**

Press **Select**

Then press   keys to set Soft Stop Curve

0 = Standard

1!! = Pump Control Curve # 1

2!! = Pump Control Curve # 2

3!! = Pump Control Curve # 3

**SOFT STOP CURVE**  
1 (STANDARD)

When setting dip sw. # 2 to on for Tacho Mode,

Press **Select**,   curve message changes to:

**STOP TACHO GAIN**  
0 (MIN GAIN)

Then press   keys to set Tacho gain:

0 = Minimum gain tacho control.

1!! = Second level tacho gain.

2!! = Third level tacho gain.

3!! = Fourth level tacho gain.

4!! = Firth level tacho gain.

5!! = Sixth level tacho gain.



**Note:** Tacho Feedback is operational in its basic form. Additional curves except for the basic linear curve are optional. Consult factory for correct tacho selection and mechanical installation.

Press **Select**

Then press   keys to set Deceleration Time. Range: 1-30 sec.

**DEC. TIME**  
10 SEC.

Press **Select**

Then press   keys to set Final Torque during Soft Stop.  
Range: 0-10 (0 = min., 10 = max.)

**FINAL TORQUE**  
0 (MIN)

Press **Select**

To store selected parameters, press **Store** key

**STORE ENABLE**  
**STOP PARAMETERS**

When parameters have been correctly stored the LCD displays:

**DATA SAVED OK**

Press **Mode**

To advance to Dual Adjustments when Dip Switch # 1 is set to ON:

**DUAL ADJUSTMENT**  
**PARAMETERS**

When selecting "Generator Mode" (Dip sw # 3 is On) the following display appears instead of the above.

**D. ADJ: GENERATOR**  
**PARAMETERS**

Press **Select**

Then press   keys to set DA Initial Voltage. Range: 10-50% of Un.

**DA: INIT. VOLT.**  
30%

Press **Select**

Then press   keys to set DA Current Limit. Range: 100-400% of motor FLA.

**DA: CUR. LIMIT**  
400% OF FLA

Press **Select**

Then press   keys to set DA Acceleration Time. Range: 1-30 sec.

**DA: ACC. TIME**  
10 SEC.

Press **Select**

Then press   keys to set DA Deceleration Time. Range: 1-30 sec.

**DA: DEC. TIME**  
10 SEC.

Press **Select**

Then press   keys to set DA Motor FLA Range: 50-100% of "STARTER FLC"

**DA: MOTOR FLA**  
150 AMP.

Press **Select**

Then press   keys to set DA Motor FLA Range: 50-100% of "STARTER FLC"

Press **Select**

To store selected parameters, press **Store** key

**STORE ENABLE**  
**D.ADJ. PARAMETERS**

When parameters have been correctly stored the LCD displays:

**DATA SAVED OK**

This concluded **DUAL ADJUSTMENT PARAMETERS** setting.

## Parameter Settings

---



**SLOW SPEED PARAMETERS** settings are kept for future enhancements.

Press **Mode**

Set Dip Switch # 1 to ON to advance to:

**FAULT PARAMETERS**

Press **Select**

Then press   keys to set Auto.Reset for Under-Voltage and Phase loss faults. Range: Yes/No.

**UV & PL AUTO RST**

Press **Select**

Then press   keys to set Under Current Auto Reset. Range: 10-120min / Off

**UNDER CUR. RESET**

**OFF**

Press **Select**

To store selected parameters press **Store** key

**STORE ENABLE**  
**FAULT PARAMETERS**

When parameters have been correctly stored, the LCD displays:

**DATA SAVED OK**

This concludes **FAULT PARAMETERS** setting.

## Parameter Settings

Press **Mode**

Set Dip Switch # 1 to ON, to Advance to:

**I/O PROGRAMMING  
PARAMETERS**

Press **Select**

Then press   keys to set Terminal # 7 function

Range: Test, Slow Speed, and Reset. Default: RESET

**PROG. INPUT # 7  
RESET**

Press **Select**

Then press   keys to set Terminal # 8 function

Range: Dual Adjustments, Slow Speed Reverse, Reset

**PROG. INPUT # 8  
DUAL ADJUSTMENT**

Press **Select**

Then press   keys to set Fault Relay function

Range: Fault, Fault – Fail Safe

**FAULT RELAY TYPE  
FAULT**

Press **Select**

Then press   keys to set Immediate Relay function

Range: Immediate, Shear-Pin

**IMM / S.PIN RELAY  
IMMEDIATE**

Press **Select**

Then press   keys to set Imm / S. Pin Relay On Delay.

Range: Immediate 0-60 sec. / Shear-Pin 0-5 sec.

**RELAY ON DELAY  
0 SEC.**

Press **Select**

Then press   keys to set Imm / S. Pin Relay Off Delay.

Range: Immediate 0-60 sec. / Shear-Pin 0-5 sec.

**RELAY OFF DELAY  
0 SEC.**

Press **Select**

Then press   keys to set Normal or Inverted output. Range: Normal, Inverted

**ANALOG OUTPUT  
NORMAL**

This concludes **I/O PARAMETER** setting.

Press **Select**

To store selected parameters, press **Store** key

**STORE ENABLE  
I / O PROG. PARAM.**

When parameters are correctly stored the LCD displays

**DATA SAVED OK**

Press **Mode**

Set Dip Switch # 1 to ON, to Advance to:

**COMM. PARAMETERS**

Communication is optional and operates only when starter incorporates this feature.

**Note:** The last command determines the function when using communication and local commands.

Press **Select**

Then press   keys to set Drive Number

**DRIVE NUMBER  
0**

(This number does not influence starter operation and is incorporated for customer convenience).

Range: 0-999

Press **Select**

Then press   keys to set Communication Baud Rate. Range: 1200-9600 BPS

**BAUD RATE  
9600**

Press **Select**

Then press   keys to set Communication Parity Check.

Range: Even/Odd

**PARITY CHECK  
EVEN**

Press **Select**

Then press   keys to set Communication Serial Link Number

Range: 1-248 (for up to 32 starters on one twisted pair)

**SERIAL LINK NO.  
248 (OFF)**

**Note:** Serial link number must be set to 248 (Off) if communication is not in use.

Press **Select**

To store selected parameters press **Store** key

**STORE ENABLE  
COMM. PARAMETERS**

When parameters have been correctly stored the LCD displays:

**DATA SAVED OK**

This concludes **COMMUNICATION PARAMETERS** setting.

## Parameter Settings

---

Press **Mode**

To advance to

STATISTICAL DATA  
\_\*\*\*\*\_

Press **Select**

LAST STRT PERIOD  
NO DATA

Displays last starting time in seconds.  
(Time duration until motor's current reached)

Press **Select**

LAST START MAXI  
NO DATA

Displays the maximum current at last starts.

Press **Select**

TOTAL RUN TIME  
0 HOURS

Displays the motor runs time in hours since commencement or since "Statistical Data" was last reset.

Press **Select**

TOTAL # OF START  
0

Displays the total numbers of starts since commissioning or since "Statistical Data" was last reset.

Press **Select**

LAST TRIP  
NO DATA  
TRIP CURRENT  
0% OF FLA

Displays the current at the last fault.

Press **Select**

TOTAL # OF TRIPS  
0

Displays the total numbers of trips since commencement or since "statistical Data" was last reset.

Press **Mode** to return to Display Only Mode

% OF MOTOR FLA

## Service Mode

Press **Mode** and  simultaneously. The LCD displays:

STORE ENABLE  
DEFAULT PARAMET.

Press **Store** and **Mode** simultaneously to store factory Default Parameters. All previously stored parameters will be erased. This also returns to "Display Only" Mode.

To reset Statistical Data:

Press **Select**

RESET STATISTICS

Press **Reset** and **Store** simultaneously to reset all your statistical data. This also returns automatically to Statistical Data Mode.

Press **Select** to see the software program version  
Displays program version

PROGRAM VERSION  
VEDA-IN MV SFT200407

For factory calibration:

Press **Select**

Read phase to phase main voltage in % of Vn.

VOLTAGE ADJUST.  
XXX % of Vn

Press **Select**

Reads current. For factory calibration use only.

CURRENT ADJUST.  
XXX% OF MV SFT FLC

Press **Select**

Display goes back to Store Enable Default Parameters

STORE ENABLE  
DEFAULT PARAMET.

To exit "Service Mode" press **Mode** and  simultaneously.

### Notes:

- Entering "Service Mode" is possible only when Stop LED is On.
- A start signal exists from this mode while in "Service Mode".



## Low voltage test with 400V motor

---

1. Connect Ground to the cubicle!!!
2. Remove clear plexi-glass cover.
3. Remove Red Glass-Epoxy cover from the fuse/transformer (6 plastic screws).
4. Remove 3 pin white Molex plug out of its socket.
5. Insert 3 pin Molex test harness plug into the socket.
6. Connect the three wires in the other side of the harness to L1, L2, L3 bus -bars (soft-starter input)
7. Connect a 400V motor (2-5KW) to terminals U, V, W
8. Connect 3 phase (no neutral) 400 Vac to L1, L2, L3.
9. Connect supply voltage to terminals 1-3 (in Control Module).
10. Connect common from your control voltage to terminal 9 ( in control module).
11. Connect terminals 4, 5, 6 together.
12. Connect a switch between terminals 4, 5, 6 and your control voltage “Hot wire” (complementary item 10).
13. Start the unit.
14. The motor will start and will trip after 5 seconds.  
The LCD displays “Bypass contactor open “although closed—that is O.K.
15. To avoid the above fault that occurs due to the lack of current in the small motor, the gain has to be increased.

To increase the measurement gain:

1. Switch off all voltages to the unit.
2. Remove front cover of control panel (4 screws)
3. Release 4 screws on the sides of the MM1 and tilt it forward.
4. Behind the MM1 unit, on the right side are three sets of 2 dip switches (see layout below).
5. Set dip switch 1 to “OFF” position on all three sets of dip switches (see layout below).
6. Start the unit again.
7. If it trips again on the same fault set dip switch 2 on all three sets of dip switches to “OFF” and repeats the process.

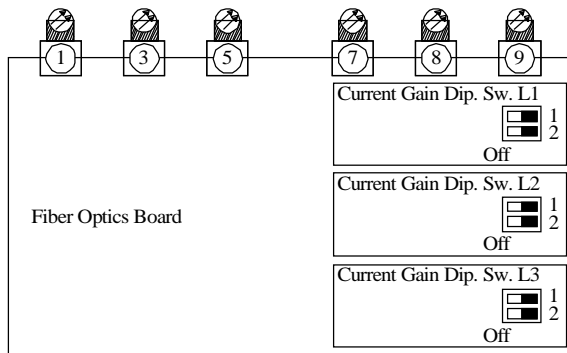

## Start-up Procedure

**Note:** It is necessary to connect a **motor** to load terminals otherwise “Wrong Connection” protection is activated. Other loads such as light-bulbs, resistors etc. may also cause “Wrong Connection” Fault.

### Start-up procedure with start-stop buttons

1. Connect Control Supply. **On** and **Stop** LED will light on.
2. Review all parameters with **Mode** and **Select** keys.  
Set parameters as required.
3. If necessary, return to Default Parameters (see “Service Mode” page 27).
4. Connect main voltage to starter line terminals.
5. Set LCD to show “MOTOR FLA” (% of motor FLA).
6. Press Start. If motor starts to turn shortly after start signal, proceed to paragraph 7. If not, increase “Initial Voltage” setting and start again.  
If initial inrush current and mechanical shocks during starting are too high, decrease “Initial Voltage” settings and proceed to paragraph 7.
7. Motor begins to turn. If speed accelerates smoothly to nominal, proceed to Para 8. If current during acceleration is too high, decrease “Current Limit” setting and proceed to Para 8. If motor speed does not accelerate to nominal, increase Current Limit setting.
8. Press Stop and wait until motor stops.
9. Slightly increase Initial Voltage and Current Limit settings to allow for load changes.
10. Press Start and see that the motor acceleration time to full speed is as required.
11. If acceleration time is too short, increase “Acceleration Time” setting.
12. Check total starting time and set Max. Start Time to approximately 5 seconds longer than the maximum time required to complete starting process.

### Examples of starting curves

#### Light Loads-Pumps, Fans, etc.

Initial Voltage (IV)–set to 30% (Factory Default)

Current Limit (CL)–set 300%

Acceleration Time (AT) – set 5 sec.

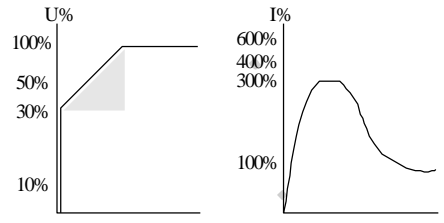

The voltage quickly increases to the Initial Voltage value and then gradually ramps-up to nominal. The current simultaneously and smoothly increases to reach Current Limit setting or less, before smoothly decreasing to the operating current. Motor speed will accelerate to full speed quickly and smoothly.

#### High Inertia Loads – Fans, Centrifuges, etc

Initial Voltage – set 50%

Current limit – set 400%

Acceleration time – set 20 sec

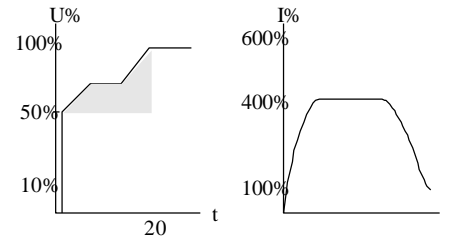

Voltage and current increase until current reaches “Current Limit”. The voltage is held at this value until motor is close to nominal speed, then current will begin to decrease. The VEDA-in MV SFT continues to ramp-up the voltage until reaching nominal. Motor speed smoothly accelerates to full speed.

#### Special starting–Using Dual Adjustment

starter will accelerate to DA-IV reaching 100% current limit. After tx (Imm. Relay delay) voltage to terminal 8 is switched off, using the standard characteristic to complete acceleration. Useful to prevent initial high acceleration in applications such as submersible pumps, drum fans with resonating frequency, etc.

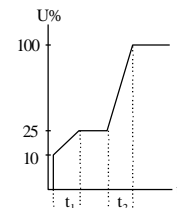

	Dual Adjust Para.	Standard Para.
Initial Voltage	10%	25%
Acceleration Time	T1 = 2-30 sec	T2 = 2-30 sec
Current Limit	200%	300-400%
Imm.Rel. ON delay	Tx = 1-60 sec.	-----

# Menu Description

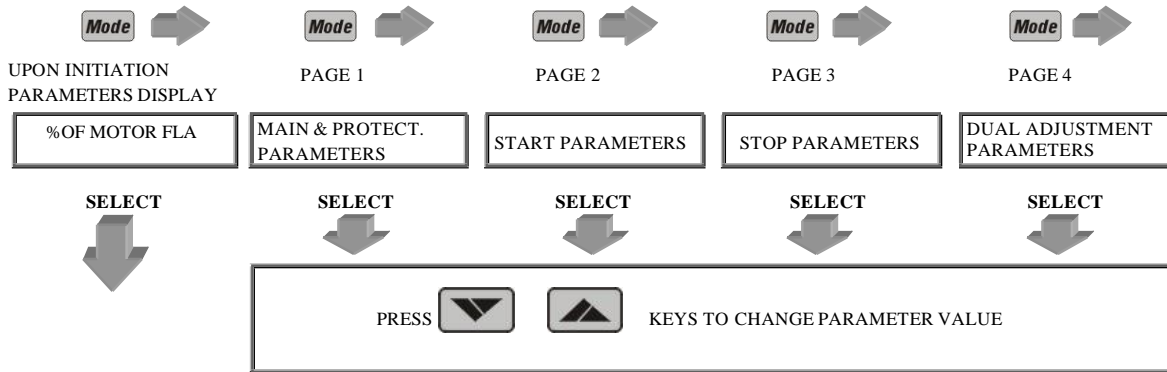

TO REVIEW OPTION CARD PARAMETERS

When DIP SW #2 is set ON change curve to Tacho mode

When DIP SW #3 is set ON

OPTION CARD Not installed	STARTER FLC 150 AMP	SOFT START CURVE 1 (STANDARD)	SOFT STOP CURVE 1 (STANDARD)	DA: GENERATOR PARAMETERS
Or if OPTION CARD is installed than:	MOTOR FLA 150 AMP	START TACHO GAIN 0 (MIN. GAIN)	STOP TACHO GAIN 0 (MIN. GAIN).	DA: INIT. VOLT. 30%
THERMISTOR RES 3.1 Kohm	UNDERCURREN. TRIP 0% OF FLA	PULSE TIME 0.0 SEC.	DEC. TIME 10 SEC.	DA: CUR. LIMIT 400% OF FLA
ANALOG OUTPUT NORMAL	UNDERCURREN. DELAY 10 SEC	INITIAL VOLTAGE 30%	FINAL TORQUE 0 (MIN).	DA: ACC. TIME 10 SEC.
	O/C – SHEAR PIN 850% OF FLA	CURRENT LIMIT 400% OF LA	STORE ENABLE STOP PARAMETERS	DA: DEC. TIME 10 SEC.
	O/C DELAY 0.5 SEC	ACC. TIME 10 SEC.		DA: MOTOR FLA 150 AMP.
	OVERLOAD TRIP 115% OF FLA	MAX START TIME 30 SEC.		STORE ENABLE D. ADJ PARAMETERS
	OVERLOAD DELAY 4 SEC. – AT 5 FLA	NUMBER OF ST ARTS 1		
	UNBALANCE TRIP 20%	STARTS PERIOD 20 MIN.		
	UNBALANCE DELAY 5 SEC.	START INHIBIT 15 MIN.		
	GND FAULT TRIP 20% OF FLA	RUN CONTACT DEL. 5 SEC.		
	GND FAULT DELAY 5 SEC.	TORRE ENABLE START ARAMETERS		
	UNDELVOLT. TRIP 75% OF Vn			
	UNDERVOLT. DELAY 5 SEC.			
	OVERVOLT. TRIP 120% OF Vn.			
	OVERVOL. DELAY 2 SEC.			
	STORE ENABLE MAIN & PROTECT.			

Back to Top (multiple instances)

# Menu Description

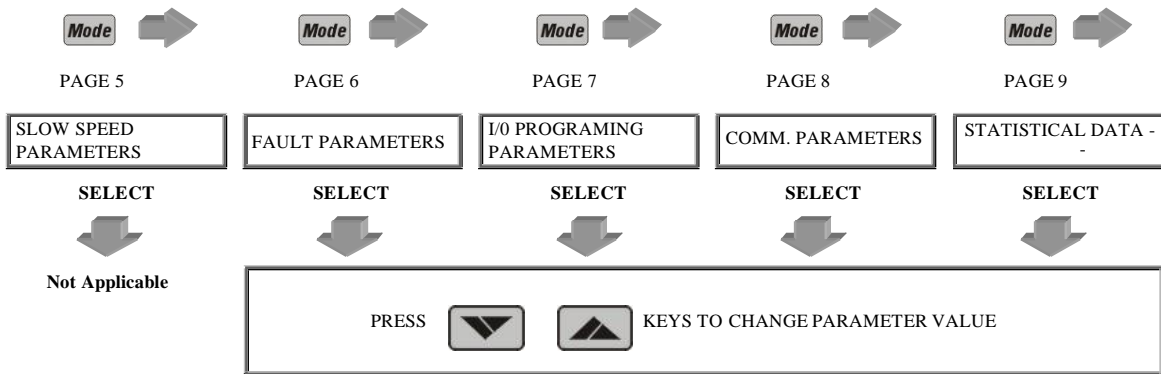

Consult factory

SLOW SPEED TORQ 8	UV& PL AUTO RESET NO	PROG. INPUT #7 RESET	DRIVE NUMBER 0	LAST STRT PERIOD X SEC.
MAX SLOW SP TIME 30 SEC	UNDER CUR. RESET OFF	PROG. INPUT #8 DUAL ADJUSTMENT	BAUD RATE 9600	LAST START MAX I X % OF FLA
STORE ENABLE SLOW SPEED	TRIP AFTER BY-PASS DO NOT PREVENT	FAULT RELAY TYPE FAULT	PARITY CHECK EVEN	TOTAL RUN TIME 0 HOURSE
	BY-PASS AUTO RST NO	IMM / S. PIN RELAY IMMEDIATE	SERIAL LINK NO. 248 (OFF)	TOTAL # OF START 0
	THERMISTOR TYPE * PTC	FAULT RELAY TYPE FAULT	PARITY CHECK EVEN	LAST TRIP NO DATA
	THERMISTOR TRIP * OFF	FAULT RELAY TYPE FAULT	STORE ENABLE COMM. PARAMETERS	TRIP CURRENT 0% OF FLA
	STORE ENABLE FAULT PARMETERS	FAULT RELAY TYPE FAULT		TOTAL # OF TRIPS 0
		RELAY ON DELAY 0 SEC.		PRE 1 – OUS TRIP NO DATA
		RELAY OFF DEL		PRE 2 – OUS TRIP NO DATA
	* For future enhance –consult factory	ANALOG OUTPUT NORMAL		PRE 9 – OUS TRIP NO DATA
		STORE ENABLE I/O PROG.		

# Menu Description

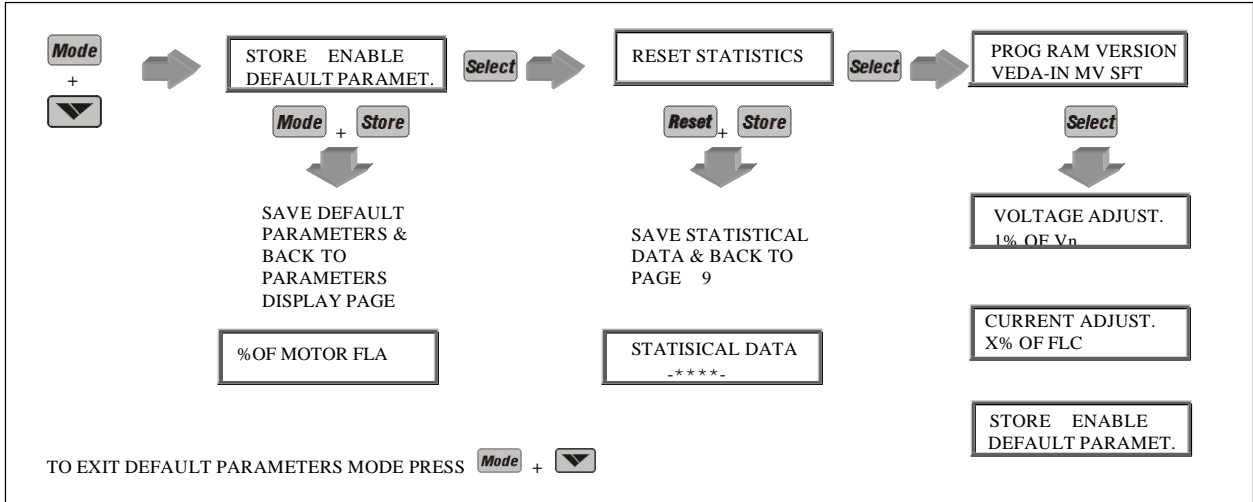

## Trouble Shooting

---

Upon fault—motor stops. Fault LED light on and Fault Relay operates. The LCD shows TRIP and fault description.  
Upon Alarm—motor continues running. Alarm Relay operates and Fault LED flashes. The LCD shows ALARM and fault description.

<b>UNBALANCE TRIP</b>	Current Unbalance is the difference between maximum and minimum values of motor three line currents divided by motor maximum current or motor FLA, whichever is greater. Fault occurs when the actual Unbalance is greater than the set point for more than “Unbalance Delay”.
<b>GND FAULT TRIP</b>	It operates when Ground Current exceeds the preset “GND FAULT TRIP” for more than “GND FAULT DLY”.
<b>PWR ON &amp; NO START</b>	It operates upon main voltage connection and activated when main voltage is connected to the VEDA-in MV SFT for more than 30 seconds without a start signal.
<b>BY-PASS OPEN SFT</b>	It operates when the by-pass contactor did not close after EOA contact of the VEDA-in M SFT
<b>TOO MANY STARTS</b>	Trips the starter if number of starts during “Start Period” exceeds the preset number. You have to wait until the motor and the starter cool down according to “Start Inhibit” setting.
<b>LONG START TIME</b>	Trips the starter if output voltage does not reach nominal at the preset max. start time. Check FLA, FLC, and max. start time settings. Increase Initial Voltage, Current Limit & max. start time or decrease acceleration Time as necessary.
<b>O/C – SHEAR PIN</b>	<p>Trips the starter:</p> <ol style="list-style-type: none"><li>1. Instantaneously when current exceeds 8.5 x Starter FLC.</li><li>2. If current exceed 8.5 x Motor FLA during starting.</li><li>3. If current exceed 200-850%</li></ol> <p>O/C Shear-Pin has a programmable delay of 0-5 seconds where the starter detects the fault and does not trip before time delay has elapsed (delay is overridden when current reaches 8.5x Starter FLC). Check that motor is not installed or Jammed. Check FLA, FLC settings. Check motor and cable connections. Perform a “Megger” test to verify motor and cables condition</p>
<b>OVERLOAD</b>	<p>Trips the starter when current exceed the Overload Trip level and thermal register has filled up.</p> <p>Check FLA, FLC and Overload settings, check the motor current, wait 15 minutes to let the motor and the starter to cool down before restarting.</p>
<b>UNDER CURRENT</b>	<p>Trips the starter when line current drops below the preset level for the preset time.</p> <p>Check “Under Current Trip” and “Time Delay” settings and check line currents through L<sub>1</sub>, L<sub>2</sub> and L<sub>3</sub>.</p>
<b>UNDER VOLTAGE</b>	<p>Trips the starter when line voltage drops below the preset level for the preset time.</p> <p>Check “Under Voltage Trip ”and “Time Delay” settings and check the line voltages on L<sub>1</sub>, L<sub>2</sub> and L<sub>3</sub>.</p> <p>When voltage drops to zero, the starter trips immediately with no delay.</p>
<b>OVER VOLTAGE</b>	<p>Trips the starter when line voltage increases above a preset level for a preset time.</p> <p>Check “Over Voltage Trip” and “Time Delay” settings. Check line voltage on L<sub>1</sub>, L<sub>2</sub> and L<sub>3</sub>.</p>
<b>PHASE LOSS</b>	Trips the starter if 1 or 2 phases are missing. Check lines voltages and correct connection (see page 4).
<b>PHASE SEQUENCE</b>	Trips the starter if line phase sequence is wrong. Check line phase sequence. If wrong, swap two wires on <u>line</u> side. If motor now rotates in the wrong direction, swap two wires on <u>load</u> side.

**CAUTION**  
Do not perform any  
“Megger” test when the  
soft-start connected!!!

## Trouble Shooting

---

### **WRONG CONNECTION or SHORTED SCR**

Trips the starter when one or more motor phases is not connected to starter load terminals or in case of internal disconnection in motor winding. If required, may be eliminated by using dip switch # 3 and wiring the soft-starter in generator mode (programming D.A. parameters accordingly\*).

### **S.SCR OR W.CON**

Trips the starter and prevents starting if any SCR is short circuited or when motor windings are shorted or when firing is incorrect (fiber optic lead incorrectly inserted may cause this fault).

Check with an ohmmeter between L<sub>1</sub>-U, L<sub>2</sub>-V, L<sub>3</sub>-W; resistance >20 KO

Check for no voltage on terminals U, V, W (from parallel system or an independent by-pass).

SCRs may fail due to:

- \* High short current not protected by proper fuses.
- \* High voltage spikes not protected by proper external Varistors.
- \* Frequent starting at maximum conditions or fault conditions.

### **OVER TEMPERATURE**

Heat-sink over-temperature trips the starter when heat-sink temperature rises above 85°C. Improve cooling or use a by-pass control. Check that motor starting is not too frequent.

### **EXTERNAL FAULT 1&2**

Trips the starter when a N.O contact between terminals 19 -21 closes for over two seconds. Check contact position and cause of closure.

### **WRONG PARAMETERS**

Parameters not transferred from RAM to EEPROM or vice versa. After replacing the

EPROM with a new software version or after power up, press **Reset**, than **Mode** and  simultaneously and save the default parameters by pressing **Store** and **Mode** simultaneously.

(If Fault LED is on, press **Reset** after storing parameters).

### **\* NOTES:**

are not

1. When operating in generator mode, shorted SCR and wrong connection fault are not active.
2. Upon any fault, check first Fiber/Optic leads and confirm correct lead insertion (full

## Technical Specification

---

### General Information:

Supply Voltage .....	Line to Line 2300V, 3300V, 4160V, 6900V 10000V(other voltages TBD) + 10% - 15%
P.I.V ratings .....	For 2300V, PIV is 6900V For 3300V, PIV is 9900V For 4160V, PIV is 12,500V For 6900V, PIV is 19,500V For 10000V, PIV is 26,000V
Frequency.....	45–65 Hz (Fixed or while frequency varies)
Control Supply .....	110-230V (to be specified) +10% - 15%
Control inputs & Outputs .....	Either same as Control Supply or by special order 24-230V AC/DC (to be specified)
Load.....	Three phase, three wire, squirrel cage induction motor.

### Start-Stop Parameters:

Starter FLC.....	Starter Full Load Current according to Selector Guide
Motor FLA .....	Motor Full Load Ampere 50-100% of starter FLC
Pump Control Curves .....	6 field selectable curves preventing over-pressure during start and water hammer during stop.
Pulse Start Duration.....	A pulse of 80% Un, for an adjustable time 0.1-2 Sec, for starting high friction loads
Initial Voltage.....	10-50% Un (*5-85%), 5% - by special order
Current Limit .....	100-400% of Motor FLA (*100-500%)
Acceleration Time .....	1-30 Sec (*1-90 sec)
Deceleration Time .....	1-30 Sec (*1-90 sec, not in Dual Adjust)
Dual Adjustments .....	Secondary start stop characteristic for: Motor FLA, Initial Voltage, Current Limit, Acceleration Time and Deceleration Time.
Tacho and Linear Acceleration.....	12 field selectable curves—defining Tacho Feedback gain improving linearity.

\* Consult Factory

### Motor Protection:

Too many starts .....	Maximum number of starts range Off or 1-10, during a time period 1-60 min.
Starts inhibit .....	Time period 1-60 min, where starting is prevented, after too many starts fault.
Long start time (Stall protection).....	Maximum allowable starting time 1-30 sec. (*1-250 Sec).
Over current (Shear-pin) .....	Two operation functions: during starting trips the starter at 850% and during running at 200-850% In, both within 1 Cycle.
Electronic overload (I <sup>2</sup> t). .....	Adjustable 75-150% of motor FLA, adjustable trips time at 500% In for 10-20 sec.
Under current.....	Trips when current drops below 20-90% In with time delay of 1-40 sec.
Under voltage** .....	Trips when main voltage drops below 70-90% of Vn. Time delay 1-10 Sec



## Technical Specification

---

Over voltage .....	Trips when main voltage increases above 110-125% of $V_n$ . Time delay of 1-10 sec.
Phase loss .....	Trips when one or two phases are missing.
Phase sequence. ....	Trips when phase sequence is wrong.
Wrong connection & Shorted SCR.....	Prevents starting, trips if motor is not connected/incorrectly connected to the starter or in case one or more SCRs have been shorted.
Heat-sink over temp. ....	Trips when heat-sink temperature rises above 85°C.
External fault 1 .....	Trips when an external contact closes for 2 sec.
External fault 2 .....	Trips when an external contact closes for 2 sec.
Unbalance Current.....	Trips when Current Unbalance exceeds preset value for more than “Unbalance delay”
Ground Fault Current. ....	Trips when Ground Fault Current exceeds preset level for more than “Gnd Fault Delay”
Power ON & No Start .....	Trips when three phases voltage is connected to the soft-starter input and start signal was not issued for more than 30 seconds.
By-Pass Open .....	Trips if the by-pass contactor and one or two if its phases did not close.

- \* Special settings, extended range
- \*\* With optional Auto Reset
- \*\*\* Future enhancement

## Technical Specification

---

### **Control:**

Displays.....	LCD in 4-Field selectable languages and 8 LEDs
Keypad .....	6 keys for easy setting
Aux. Contact – Immediate.....	1 C/O, 8A, 250VAC, 2000VA
Aux. Contact – End of Acceleration....	1 C/O, 8A, 250VAC, 2000VA
Fault Contact .....	1 C/O, 8A, 250VAC, 2000VA
Communication.....	RS 485 with MODBUS protocol for full control and supervision

<b><u>Temperatures</u></b> .....	Operating -10° to 50°C Storage -20° to 70°C
----------------------------------	--

### **Standards:**

Degree of Protection.....	IP 00 IP 3x and higher—consult factory.
---------------------------	--

### **Normal Service Conditions:**

Altitude.....	Should not exceed 1000m. Consult factory for equipment to be used at higher altitudes.
Humidity.....	Should not exceed 95% at +50°C or 98% at 45°C.

### **Starter Consumption Ratings:**

Total control consumption.....	250VA
--------------------------------	-------